

PRODUCT CATALOGUE

HOME CARE

- + Active respiratory gas humidification
- + Breathing sets heated
- + Breathing sets unheated
- + Patient interfaces
- + Sleep therapy
- + Accessories



QUALITY BORN
FROM PASSION

SUSTAINABLE
PRODUCTION

www.wilamed.com

INDIVIDUAL
SOLUTIONS



Managers, decision-makers and healthcare professionals need clear information to quickly and easily select the right equipment for a wide range of treatment therapies in respiratory medicine.

Our product range reflects the knowledge we have gained over many years from hospitals in a wide range of countries.

If you have any questions about our products, please contact your WILAméd representative.



QUALITY BORN FROM PASSION

WILAméd products not only comply with legal medical technology standards but are also measured against our own strict quality requirements.



SUSTAINABLE PRODUCTION

Modern, environmentally friendly production facilities and manufacturing processes, social responsibility, and sustainable investments at our Germany location ensure consistent product and process quality at the highest level.



OPTIMIZED SOLUTIONS

The result is perfectly coordinated products that ensure the best possible patient care.



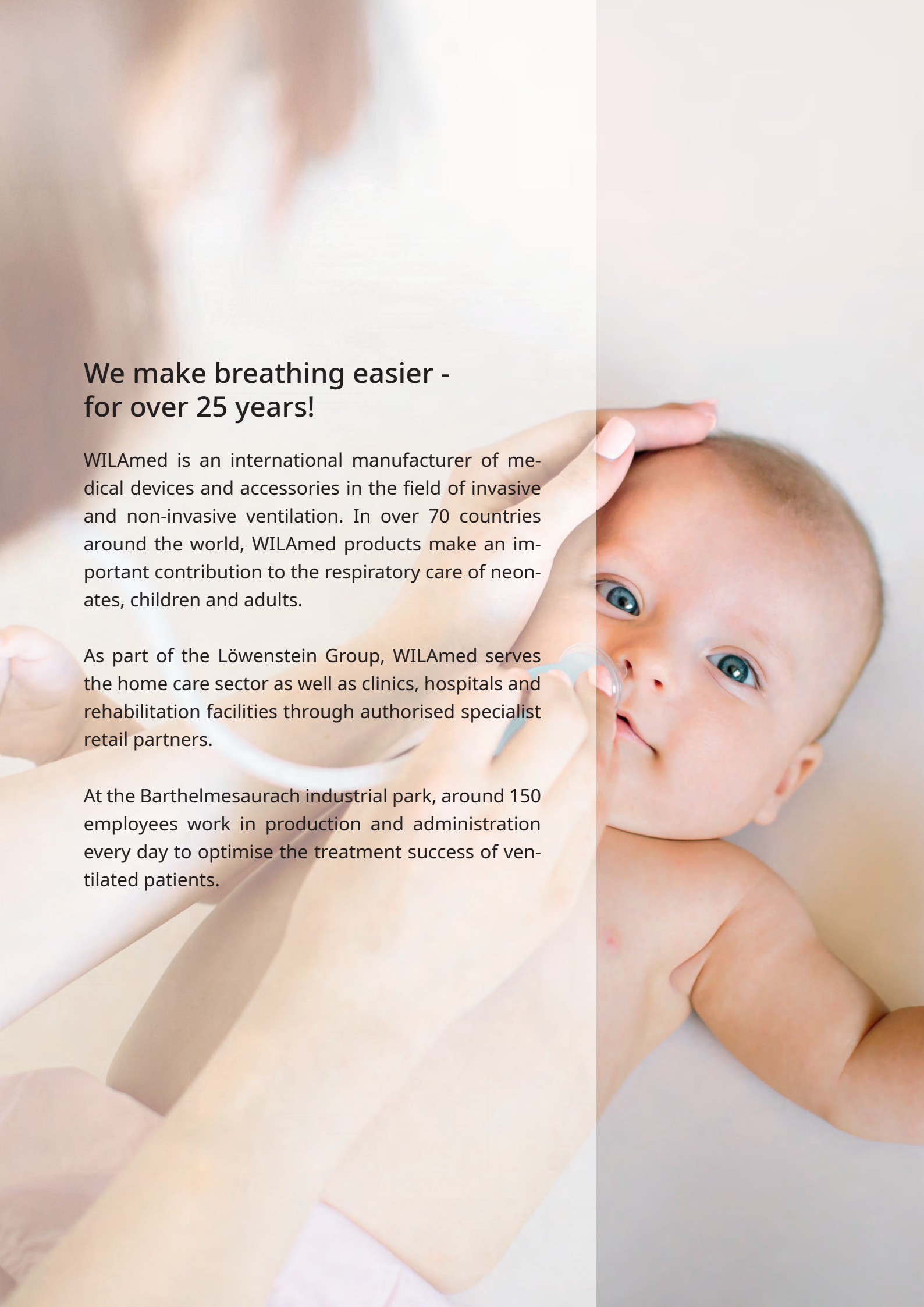

We make breathing easier - for over 25 years!

WILAméd is an international manufacturer of medical devices and accessories in the field of invasive and non-invasive ventilation. In over 70 countries around the world, WILAméd products make an important contribution to the respiratory care of neonates, children and adults.

As part of the Löwenstein Group, WILAméd serves the home care sector as well as clinics, hospitals and rehabilitation facilities through authorised specialist retail partners.

At the Barthelmesaurach industrial park, around 150 employees work in production and administration every day to optimise the treatment success of ventilated patients.

TABLE OF CONTENTS

VENTILATION

ACTIVE RESPIRATORY GAS HUMIDIFIERS.....	5
MOUNTS & BRACKETS FOR HUMIDIFIERS	8
STERILE WATER	10
BREATHING SETS HEATED	11
HUMIDIFIER CHAMBERS	35
BREATHING SETS UNHEATED	37
BREATHING SETS UNHEATED - CLEARline for mechanical insufflator-exsufflator (MI-E)	53
DISPOSABLE PATIENT INTERFACES.....	54

SLEEP THERAPY/NIV VENTILATION

HEATED BREATHING TUBE - CozyLine & CozyTube.....	56
UNHEATED BREATHING TUBE - AIRline	57
PATIENT INTERFACES.....	58
HEADSTRAPS FOR PATIENT INTERFACES.....	59
ACCESSORIES	61

The images are for illustrative purposes only.

„Treatment unit“ refers to a combination of products packaged together and marketed for use for a specific medical purpose.

*All trademarks and brand names are the property of their respective owners.
Any use thereof does not imply affiliation with or endorsement by them.*



ACTIVE RESPIRATORY GAS HUMIDIFIERS

AIRcon Gen2 Respiratory Humidifier



The **WILamed AIRcon Gen2 respiratory humidifier** is an effective complete solution for optimal respiratory humidification of mechanically ventilated (invasive and non-invasive) patients.

By warming and humidifying the respiratory gas, the natural cleansing function of the lungs, mucociliary clearance, is supported. This effectively reduces the risk of pulmonary infections or damaged lung tissue is thus effectively reduced.

The comprehensively upgraded AIRcon Gen2 is one of the most advanced respiratory gas humidifiers currently available on the market.

As a fully equipped respiratory humidification set, the AIRcon Gen2 with its extensive range of accessories is quick and easy to install, ensuring safe operation.

The **AIRcon respiratory gas humidifier series** has been well received by healthcare professionals since 2010 – whether in intensive care or home ventilation.

Scope of delivery:

- Respiratory humidifier / basic unit
- Electric heating wire adapter (INSP and EXP)
- Temperature probe

Item	Part number	QTY
AIRcon Gen2 humidifier 220 - 240 V Version	101200	1
AIRcon Gen2 humidifier 110 - 120 V Version	101201	1

AIRniva Humidifier



The **WILAMED respiratory gas humidifier AIRniva** is an effective complete solution for optimal respiratory gas humidification of non-invasively ventilated patients.

By warming and humidifying the respiratory gas, the natural cleaning function of the lungs, known as mucociliary clearance, is supported.

This effectively reduces the risk of pulmonary infections or damage to lung tissue.

Scope of delivery:

- Heater Base / main unit
- Reusable Heater Wire Adapter INSP

Item	Part number	QTY
AIRniva humidifier 220 - 240 V Version	100500	1
AIRniva humidifier 110 - 120 V Version	100505	1

Dual Heater Wire Adapter INSP + EXP



Dual heating wire adapter for WILAMED dual limb sets.

Only for use on the AIRcon humidifier!

Item	Part number	QTY
Dual Heater Wire Adapter INSP + EXP	100929	1



Single Heater Wire Adapter INSP only



Heating wire adapter only for inspiratory heated WILAmEd breathing sets.

Suitable for use on AIRcon and AIRniva.

Item	Part number	QTY
Single Heater Wire Adapter INSP only	100942	1

Temperature Probe



Suitable for use on AIRcon and AIRniva.

Item	Part number	QTY
Temperature Probe 160 cm	100910	1
Temperature Probe 180 cm	100909	1

MOUNTS & BRACKETS FOR HUMIDIFIERS

C-clamp



Our standard c-clamp is designed to mount horizontally or vertically on round surfaces (e.g. I.V. poles), with a maximum diameter of 40 mm.

Item	Part number	QTY
C-Clamp	550301	1

Mounting Bracket Kit for Norm Rail



Our angled attachment unit is intended, for example, for attaching the AIRcon respiratory gas humidifier to standard rails.

Item	Part number	QTY
Mounting Bracket Kit for Norm Rail	550247	1



Telescopic Water Bag Pole



Water bottle holder with telescopic rod and holder for respiratory gas humidifier, for attachment to standard rails in clinical and non-clinical environments.

Item	Part number	QTY
Water bottle holder with telescopic rod	550220	1

STERILE WATER

WILAqua sterile water

* Only available in selected markets.
Contact us for further information.



WILAqua sterile water is produced in state-of-the-art manufacturing facilities and has been specially developed to meet the demanding hygiene requirements of invasive and non-invasive ventilated patients. It is distilled sterile water.

Item	Part number	QTY
WILAqua sterile water for respiratory gas humidification, 1000 ml PE bottle	500186	10
WILAqua sterile water for respiratory gas humidification, 1000 ml PE bottle	5001862	660



WILAqua sterile water, oval bottle

* Only available in selected markets.
Contact us for further information.



Item	Part number	QTY
WILAqua sterile water for respiratory gas humidification, 1000 ml PE oval bottle	50018810	10
WILAqua sterile water for respiratory gas humidification, 1000 ml PE oval bottle	500188600	600



BREATHING SETS HEATED

For use with LÖWENSTEIN LUISA

Breathing set heated, single limb with active valve

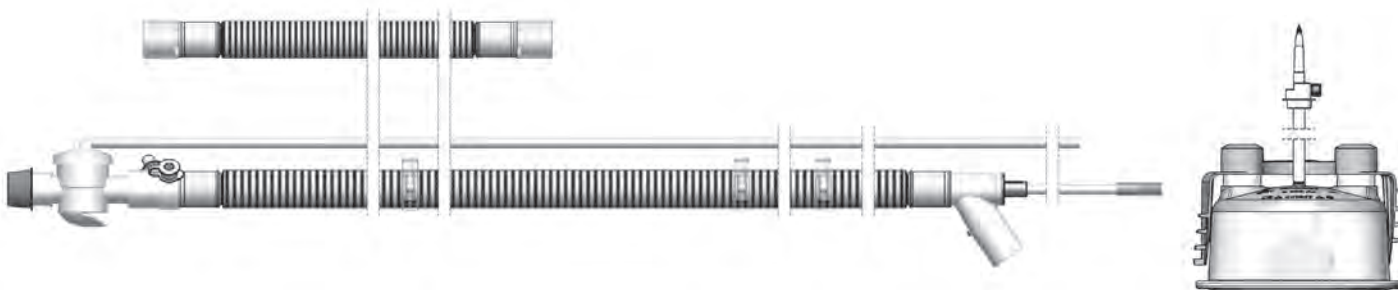

Description: **Breathing set heated (i), single limb**
 Valve: Active valve with pressure and control line
 Diameter: 22 mm
 Length: 150 cm heated
 Flow range: 4 - 80 l/min
 Connecting tube: 60 cm
 Humidification chamber: C200AF Auto-fill, only suitable for use with **AIRcon Gen2**
 Service life: Disposable system, max. 7 days

Adults



Item	Part number	QTY
BTS8119A, Breathing set heated, incl. AF humidification chamber	27173910	10

Breathing set heated, single limb with active valve

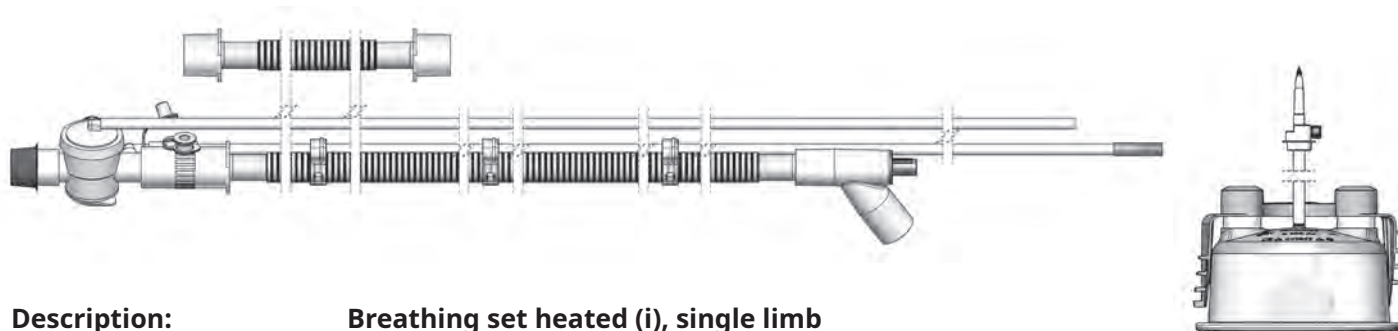

Description: **Breathing set heated (i), single limb**
 Valve: Active valve with pressure and control line
 Diameter: 15 mm
 Length: 150 cm heated
 Flow range: 3 - 30 l/min
 Connecting tube: 60 cm
 Humidification chamber: C200AF Auto-fill, only suitable for use with **AIRcon Gen2**
 Service life: Disposable system, max. 7 days

Children



Item	Part number	QTY
BTS6076A, Breathing set heated, incl. AF humidification chamber	27173810	10

Breathing set heated, dual limb with Y-piece

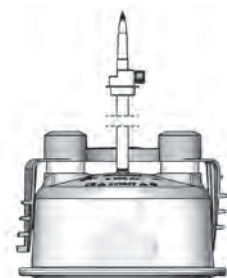
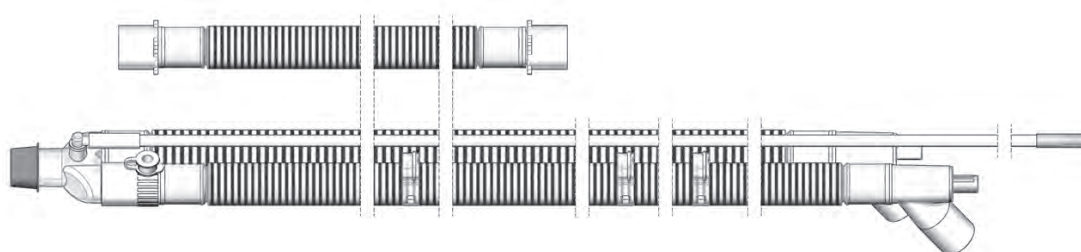

Description:

Breathing set heated (i+e), dual limb

Y-piece with pressure line
 Diameter: 22 mm
 Length: 150 cm heated
 Flow range: 4 - 80 l/min
 Connecting tube: 60 cm
 Humidification chamber: C200AF Auto-fill, only suitable for use with **AIRcon Gen2**
 Service life: Disposable system, max. 7 days

Adults



Item	Part number	QTY
BTS8117A, Breathing set heated, incl. AF humidification chamber	27173510	10

Breathing set heated, dual limb with Y-piece

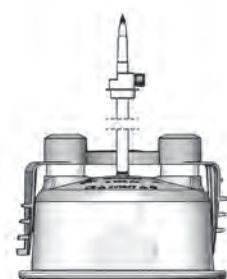
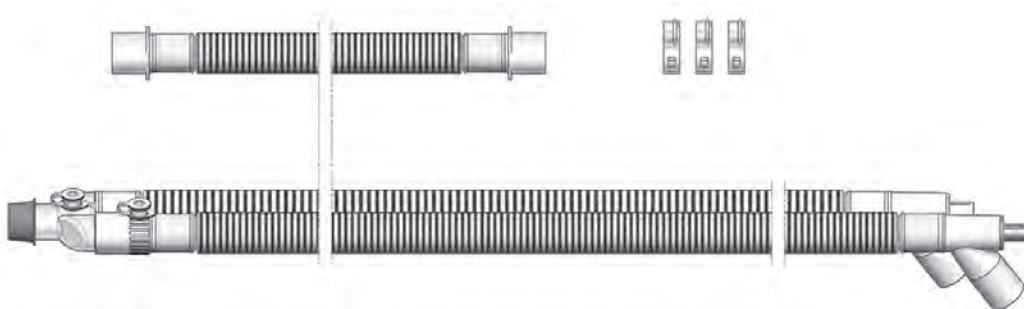

Description:

Breathing set heated (i+e), dual limb

Y-piece
 Diameter: 22 mm
 Length: 150 cm heated
 Flow range: 4 - 80 l/min
 Connecting tube: 60 cm
 Humidification chamber: C200AF Auto-fill, only suitable for use with **AIRcon Gen2**
 Service life: Disposable system, max. 7 days

Adults



Item	Part number	QTY
BTS8128A, Breathing set heated, incl. AF humidification chamber	27175810	10



Breathing set heated, dual limb with Y-piece

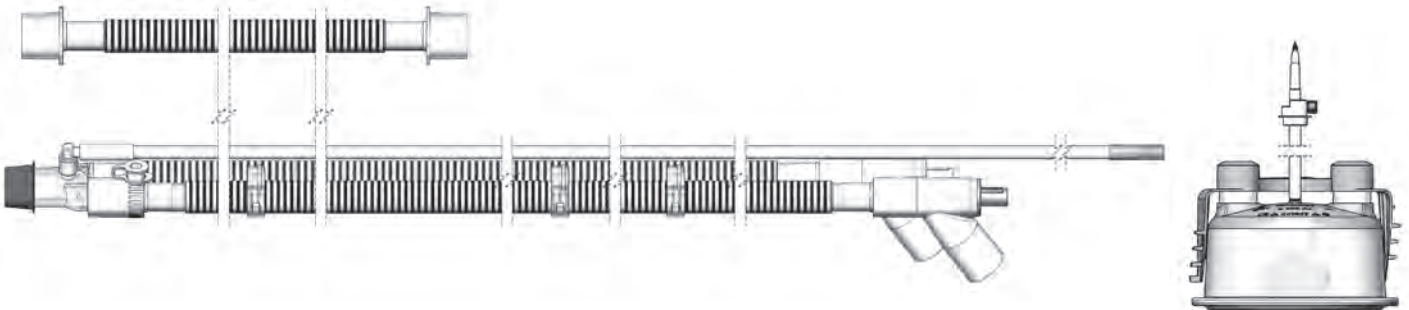

Description: **Breathing set heated (i+e), dual limb**
 Y-piece with pressure line
 Diameter: 15 mm
 Length: 150 cm heated
 Flow range: 3 - 30 l/min
 Connecting tube: 60 cm
 Humidification chamber: C200AF Auto-fill, only suitable for use with **AIRcon Gen2**
 Service life: Disposable system, max. 7 days

Children



Item	Part number	QTY
BTS6075A, Breathing set heated, incl. AF humidification chamber	27173610	10

Breathing set heated, dual limb with Y-piece

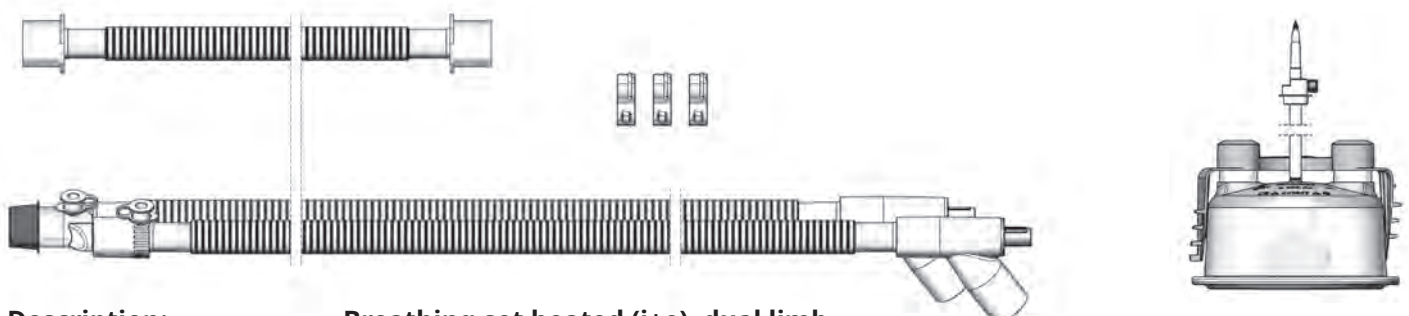

Description: **Breathing set heated (i+e), dual limb**
 Y-piece
 Diameter: 15 mm
 Length: 150 cm heated
 Flow range: 3 - 30 l/min
 Connecting tube: 60 cm
 Humidification chamber: C200AF Auto-fill, only suitable for use with **AIRcon Gen2**
 Service life: Disposable system, max. 7 days

Children



Item	Part number	QTY
BTS2181A, Breathing set heated, incl. AF humidification chamber	27122310	10

Breathing set heated, dual limb with Y-piece

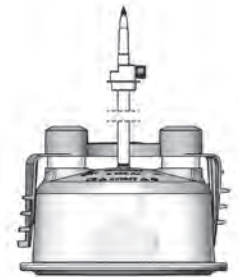
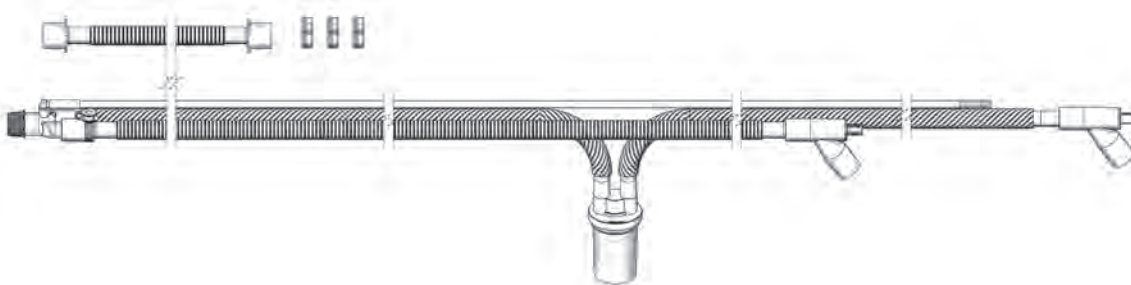

Description:

Breathing set heated (i+e), dual limb with water trap

Y-piece with pressure line
 Diameter: 15 mm
 Length: 150 cm heated
 Flow range: 3 - 30 l/min
 Connecting tube: 60 cm
 Humidification chamber: C200AF Auto-fill, only suitable for use with **AIRcon Gen2**
 Service life: Disposable system, max. 7 days

Children



Item	Part number	QTY
BTS6095A, Breathing set heated, incl. AF humidification chamber	27178710	10

Breathing set heated, dual limb with Y-piece

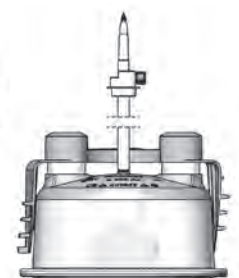
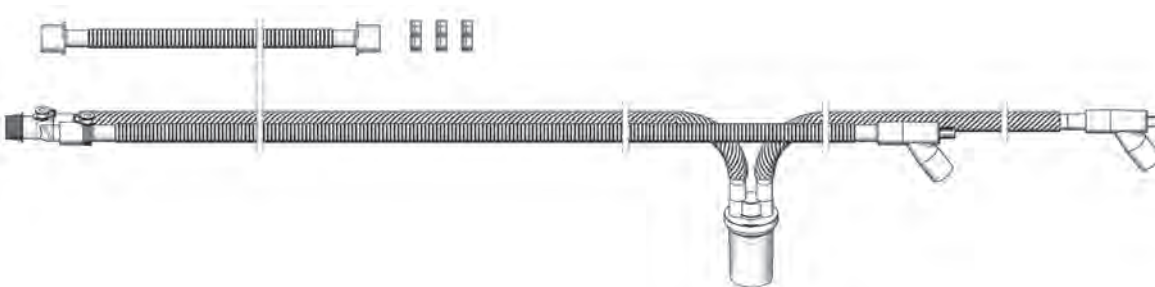

Description:

Breathing set heated (i+e), dual limb with water trap

Y-piece
 Diameter: 15 mm
 Length: 150 cm heated
 Flow range: 3 - 30 l/min
 Connecting tube: 60 cm
 Humidification chamber: C200AF Auto-fill, only suitable for use with **AIRcon Gen2**
 Service life: Disposable system, max. 7 days

Children



Item	Part number	QTY
BTS6038A, Breathing set heated, incl. AF humidification chamber	27150810	10



Breathing set heated, dual limb with Y-piece

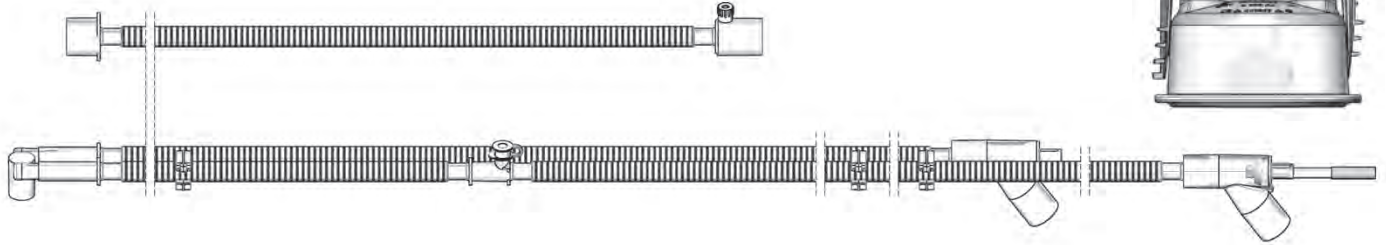

Description: **Breathing set heated (i+e), dual limb**
 Y-piece with pressure line
 Diameter: 10 mm
 Length: 120 cm heated
 Flow range: 2 - 15 l/min
 Connecting tube: 60 cm
 Humidification chamber: C200AF Auto-fill, only suitable for use with **AIRcon Gen2**
 Service life: Disposable system, max. 7 days



Item	Part number	QTY
BTS4042A , Breathing set heated, incl. AF humidification chamber	27174010	10

Breathing set heated, dual limb with Y-piece

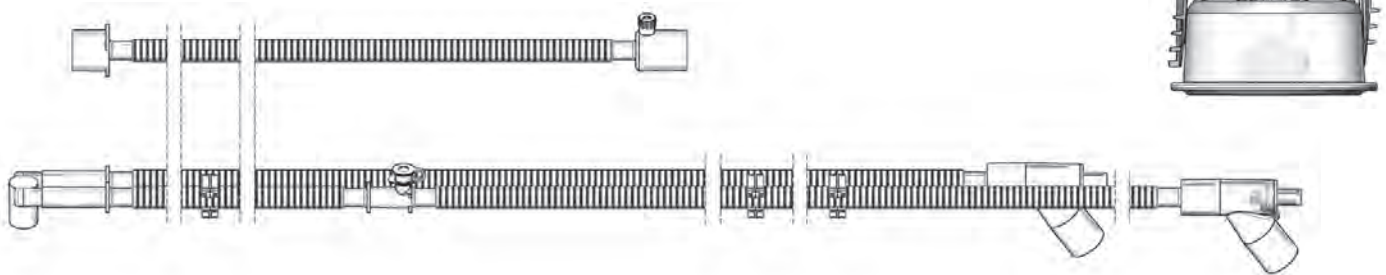

Description: **Breathing set heated (i+e), dual limb**
 Y-piece
 Diameter: 10 mm
 Length: 120 cm heated
 Flow range: 2 - 15 l/min
 Connecting tube: 60 cm
 Humidification chamber: C200AF Auto-fill, only suitable for use with **AIRcon Gen2**
 Service life: Disposable system, max. 7 days



Item	Part number	QTY
BTS1361A, Breathing set heated, incl. AF humidification chamber	27175510	10

Breathing set heated, single limb with passive valve WILAsilent 2

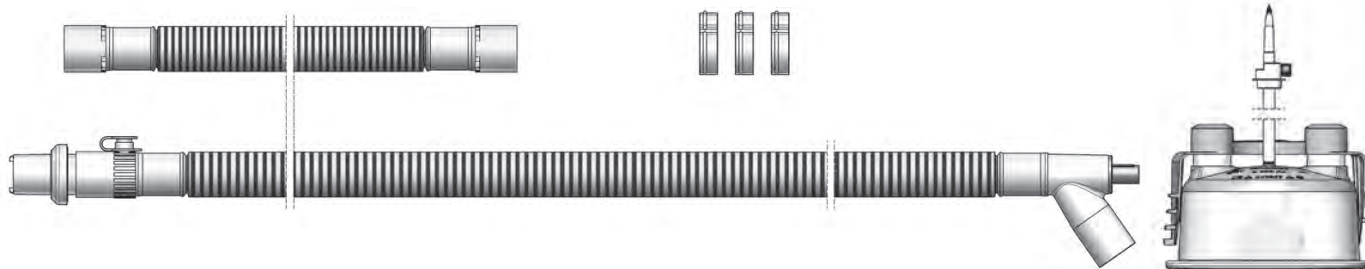

Description:

Valve: Passive valve WILAsilent 2 attached
Diameter: 22 mm
Length: 150 cm heated
Flow range: 4 - 80 l/min
Connecting tube: 60 cm
Humidification chamber: C200AF Auto-fill, only suitable for use with **AIRcon Gen2**
Service life: Disposable system, max. 7 days

Adults



Item	Part number	QTY
BTS3268A, Breathing set heated, incl. AF humidification chamber	27115610	10

Breathing set heated, single limb for vented masks or high-flow therapy

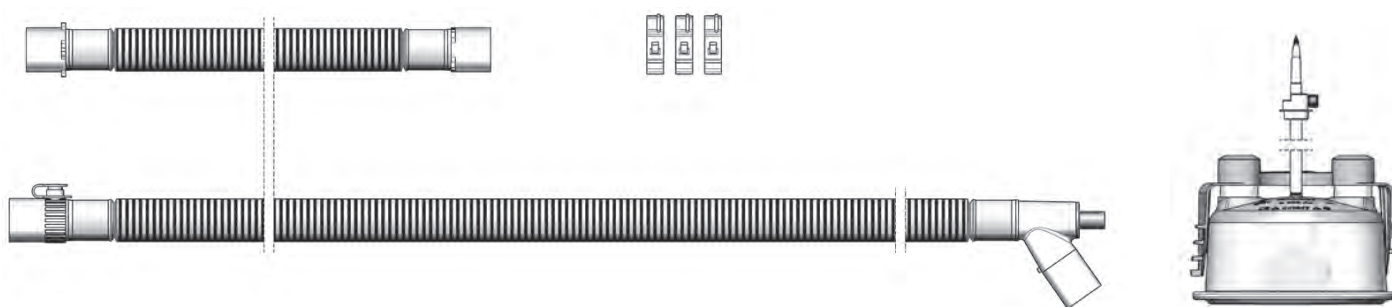

Description:

Valve: N/A
Diameter: 22 mm
Length: 150 cm heated
Flow range: 4 - 80 l/min
Connecting tube: 60 cm
Humidification chamber: C200AF Auto-fill, only suitable for use with **AIRcon Gen2**
Service life: Disposable system, max. 7 days

Adults



Item	Part number	QTY
BTS3234A, Breathing set heated, incl. AF humidification chamber	27112510	10



Breathing set heated, single limb with passive valve WILAsilent 2

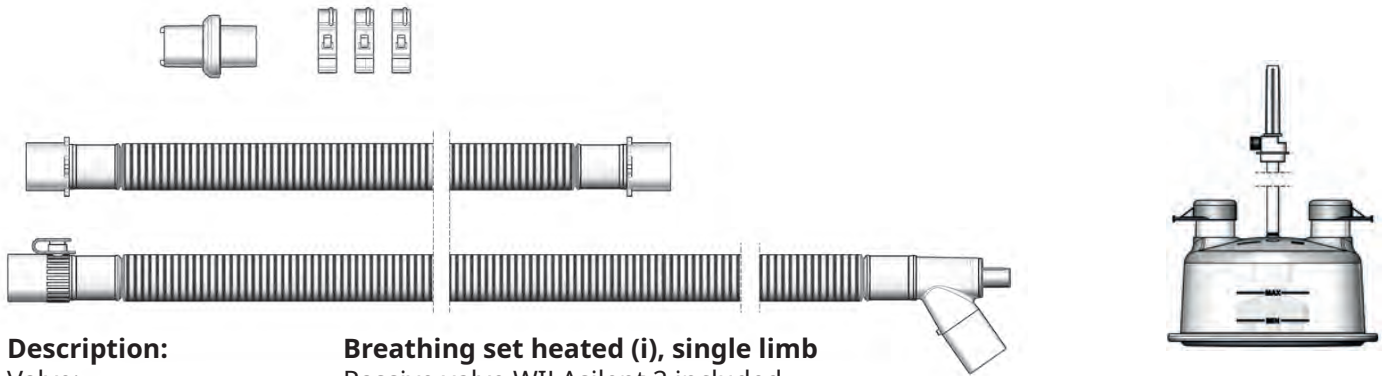

Description: **Breathing set heated (i), single limb**
 Valve: Passive valve WILAsilent 2 included
 Diameter: 22 mm
 Length: 150 cm heated
 Flow range: 4 - 80 l/min
 Connecting tube: 60 cm
 Humidification chamber: C200AF Auto-fill universal, only suitable for use with **AIRniva**
 Service life: Disposable system, max. 7 days



Item	Part number	QTY
BTS8099A, Breathing set heated, incl. AF humidification chamber	27170510	10

Breathing set heated, single limb with passive valve WILAsilent 2

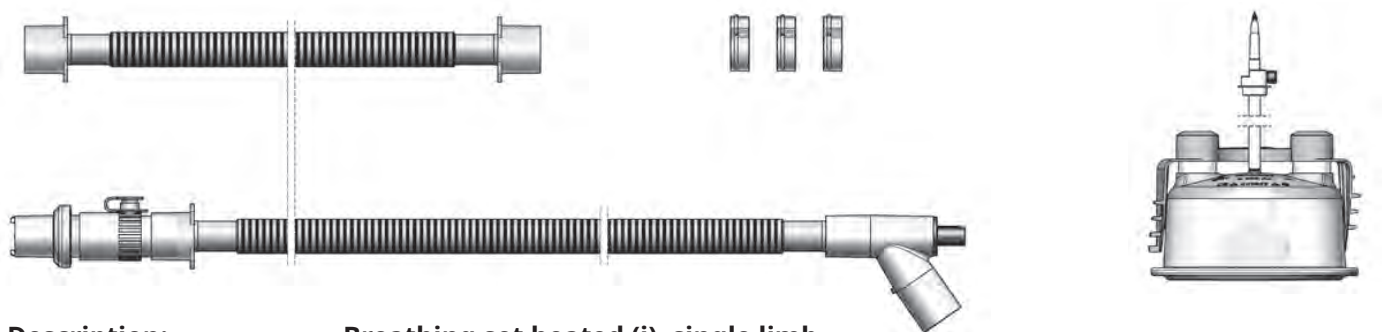

Description: **Breathing set heated (i), single limb**
 Valve: Passive valve WILAsilent 2 attached
 Diameter: 15 mm
 Length: 150 cm heated
 Flow range: 3 - 30 l/min
 Connecting tube: 60 cm
 Humidification chamber: C200AF Auto-fill, only suitable for use with **AIRcon Gen2**
 Service life: Disposable system, max. 7 days



Item	Part number	QTY
BTS2142A , Breathing set heated, incl. AF humidification chamber	27115710	10

Breathing set heated, single limb for vented masks or high-flow therapy

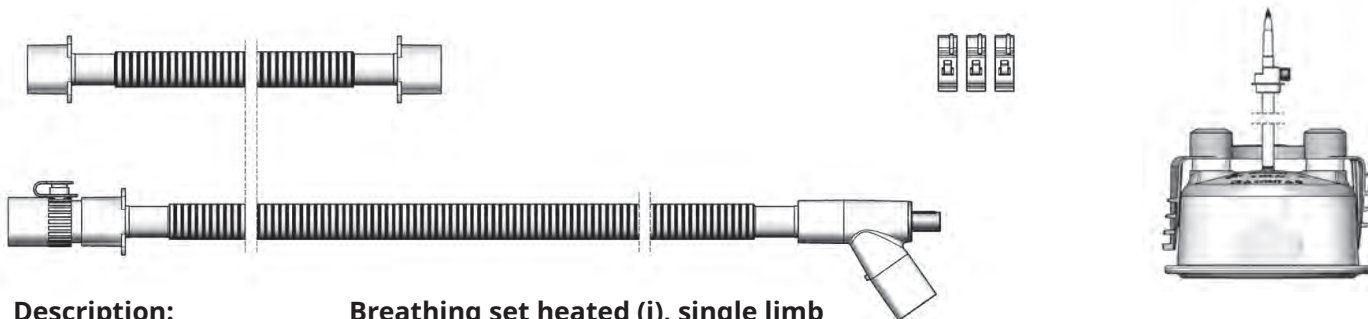

Description: **Breathing set heated (i), single limb**
 Valve: N/A
 Diameter: 15 mm
 Length: 150 cm heated
 Flow range: 3 - 30 l/min
 Connecting tube: 60 cm
 Humidification chamber: C200AF Auto-fill, only suitable for use with **AIRcon Gen2**
 Service life: Disposable system, max. 7 days



Item	Part number	QTY
BTS2171A, Breathing set heated, incl. AF humidification chamber	27151910	10



For use with Breas Vivo 45LS/55 and Vivo 65 ventilators

Breathing set heated, single limb with active valve

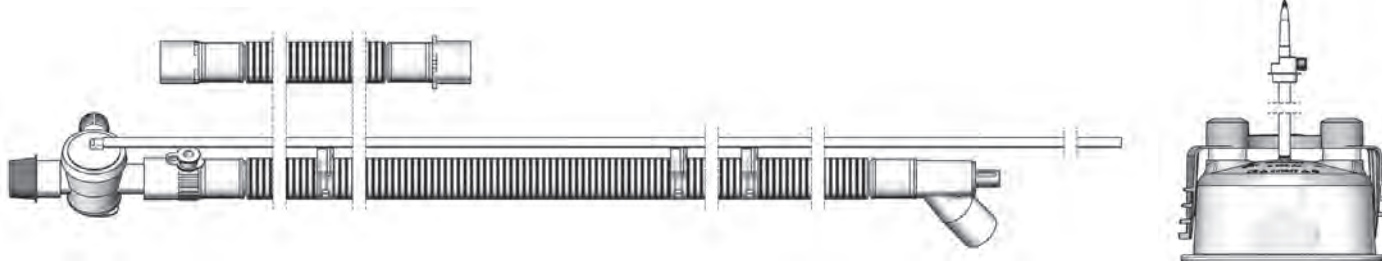

Description: **Breathing set heated (i), single limb**
 Valve: Active valve with pressure and control line
 Diameter: 22 mm
 Length: 150 cm heated
 Flow range: 4 - 80 l/min
 Connecting tube: 60 cm
 Humidification chamber: C200AF Auto-fill, only suitable for use with **AIRcon Gen2**
 Service life: Disposable system, max. 7 days



Item	Part number	QTY
BTS3238A, Breathing set heated, incl. AF humidification chamber	27112810	10

Breathing set heated, single limb with active valve

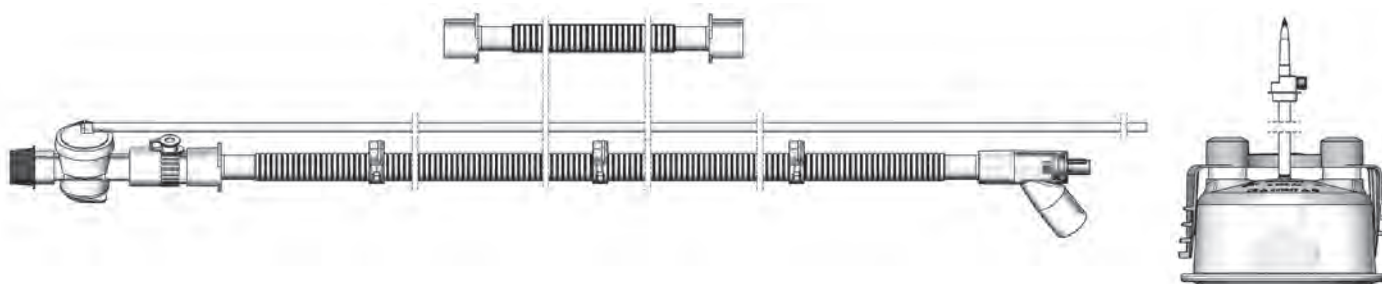

Description: **Breathing set heated (i), single limb**
 Valve: Active valve with pressure and control line
 Diameter: 15 mm
 Length: 150 cm heated
 Flow range: 3 - 30 l/min
 Connecting tube: 60 cm
 Humidification chamber: C200AF Auto-fill, only suitable for use with **AIRcon Gen2**
 Service life: Disposable system, max. 7 days



Item	Part number	QTY
BTS2125A, Breathing set heated, incl. AF humidification chamber	27113210	10

Breathing set heated, dual limb (only for Vivo 65)

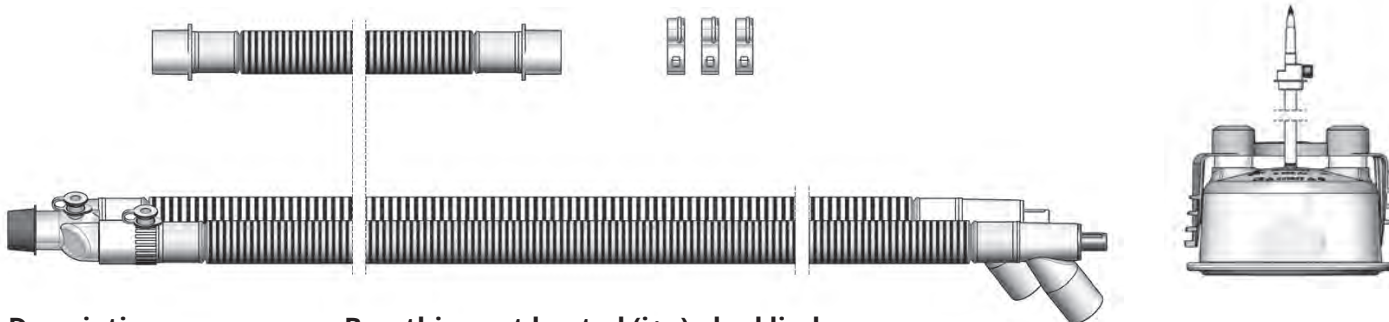

Description: Breathing set heated (i+e), dual limb
 Y-piece
 Diameter: 22 mm
 Length: 150 cm heated
 Flow range: 4 - 80 l/min
 Connecting tube: 60 cm
 Humidification chamber: C200AF Auto-fill, only suitable for use with **AIRcon Gen2**
 Service life: Disposable system, max. 7 days



Item	Part number	QTY
BTS3481A, Breathing set heated, incl. AF humidification chamber	27176010	10

Breathing set heated, dual limb (only for Vivo 65)

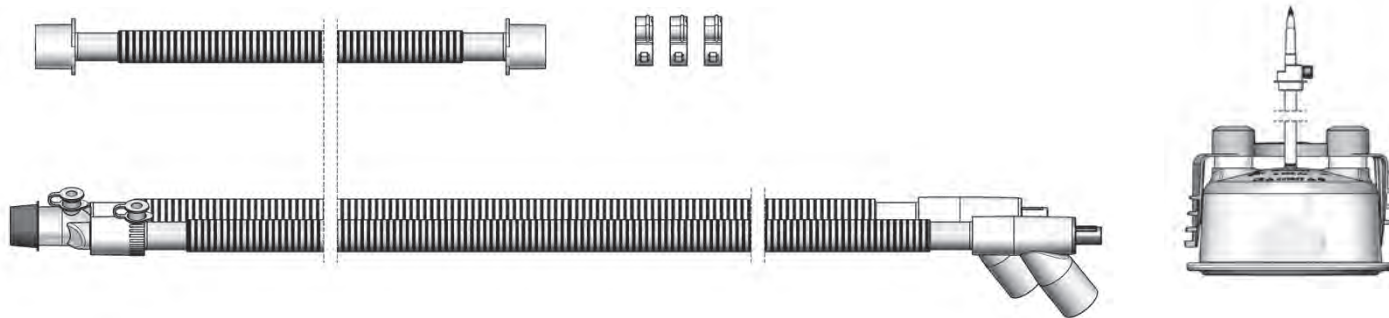

Description: Breathing set heated (i+e), dual limb
 Y-piece
 Diameter: 15 mm
 Length: 150 cm heated
 Flow range: 3 - 30 l/min
 Connecting tube: 60 cm
 Humidification chamber: C200AF Auto-fill, only suitable for use with **AIRcon Gen2**
 Service life: Disposable system, max. 7 days



Item	Part number	QTY
BTS2260A, Breathing set heated, incl. AF humidification chamber	27176110	10



Breathing set heated, single limb with passive valve WILAsilent 2

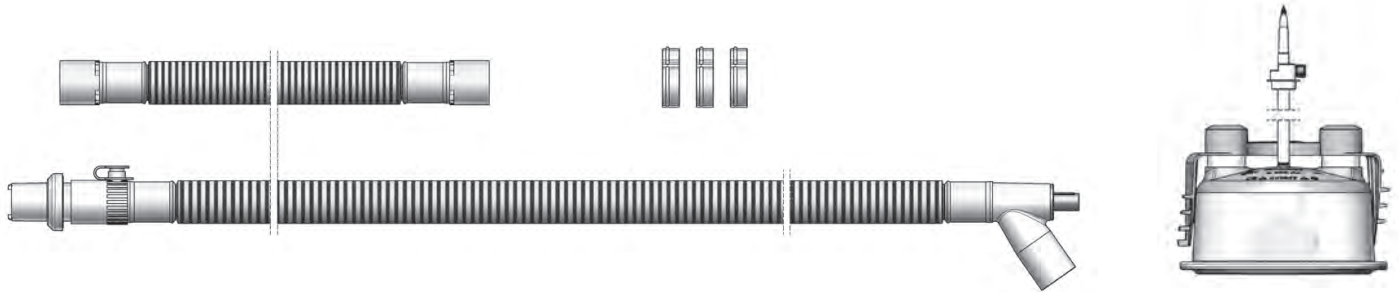

Description: **Breathing set heated (i), single limb**
 Valve: Passive valve WILAsilent 2 attached
 Diameter: 22 mm
 Length: 150 cm heated
 Flow range: 4 - 80 l/min
 Connecting tube: 60 cm
 Humidification chamber: C200AF Auto-fill, only suitable for use with **AIRcon Gen2**
 Service life: Disposable system, max. 7 days



Item	Part number	QTY
BTS3268A, Breathing set heated, incl. AF humidification chamber	27115610	10

Breathing set heated, single limb for vented masks and high-flow therapy

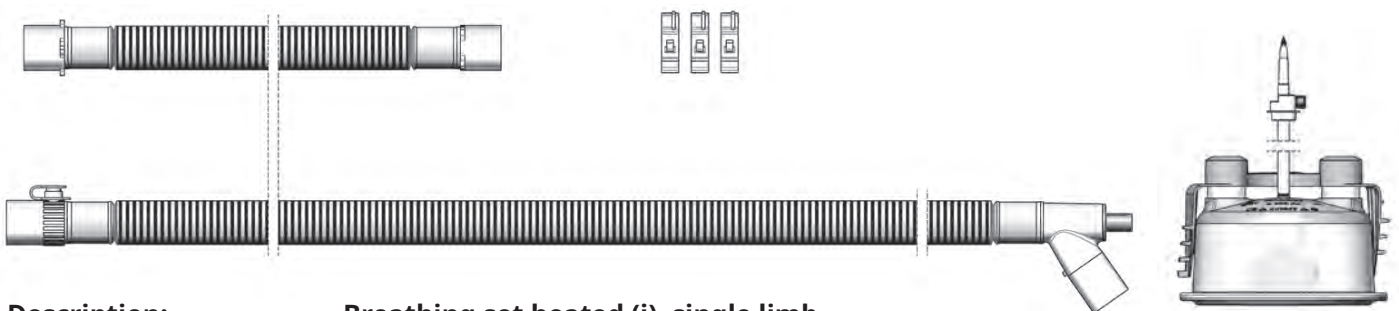

Description: **Breathing set heated (i), single limb**
 Valve: N/A
 Diameter: 22 mm
 Length: 150 cm heated
 Flow range: 4 - 80 l/min
 Connecting tube: 60 cm
 Humidification chamber: C200AF Auto-fill, only suitable for use with **AIRcon Gen2**
 Service life: Disposable system, max. 7 days



Item	Part number	QTY
BTS3234A, Breathing set heated, incl. AF humidification chamber	27112510	10

Breathing set heated, single limb with passive valve WILAsilent 2

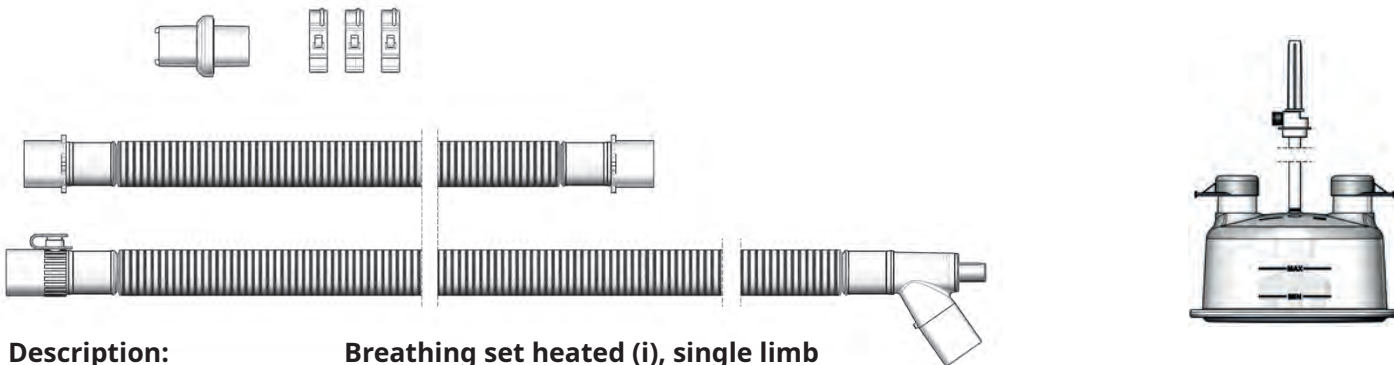

Description: **Breathing set heated (i), single limb**
 Valve: Passive valve WILAsilent 2 included
 Diameter: 22 mm
 Length: 150 cm heated
 Flow range: 4 - 80 l/min
 Connecting tube: 60 cm
 Humidification chamber: C200AF Auto-fill universal, only suitable for use with **AIRniva**
 Service life: Disposable system, max. 7 days



Item	Part number	QTY
BTS8099A, Breathing set heated, incl. AF humidification chamber	27170510	10

Breathing set heated, single limb with passive valve WILAsilent 2

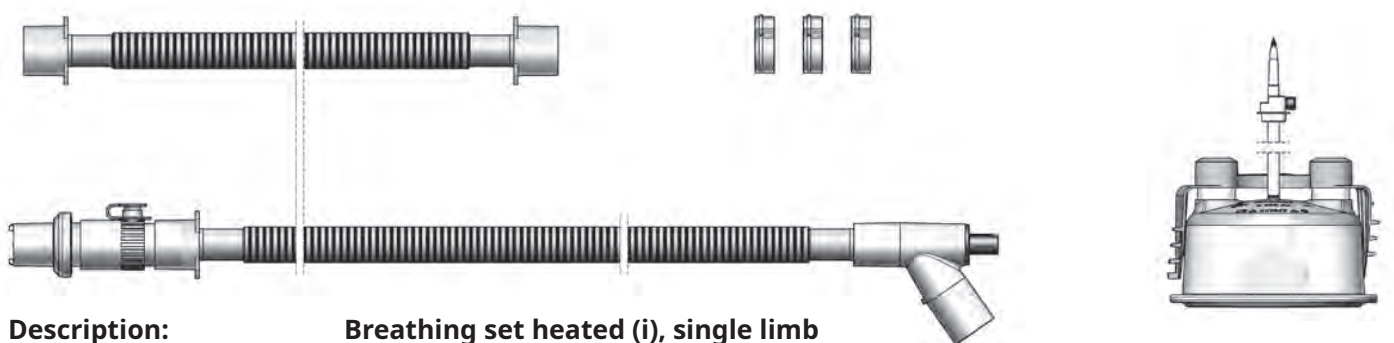

Description: **Breathing set heated (i), single limb**
 Valve: Passive valve WILAsilent 2 attached
 Diameter: 15 mm
 Length: 150 cm heated
 Flow range: 3 - 30 l/min
 Connecting tube: 60 cm
 Humidification chamber: C200AF Auto-fill, only suitable for use with **AIRcon Gen2**
 Service life: Disposable system, max. 7 days



Item	Part number	QTY
BTS2142A , Breathing set heated, incl. AF humidification chamber	27115710	10



Breathing set heated, single limb for vented masks and high-flow therapy

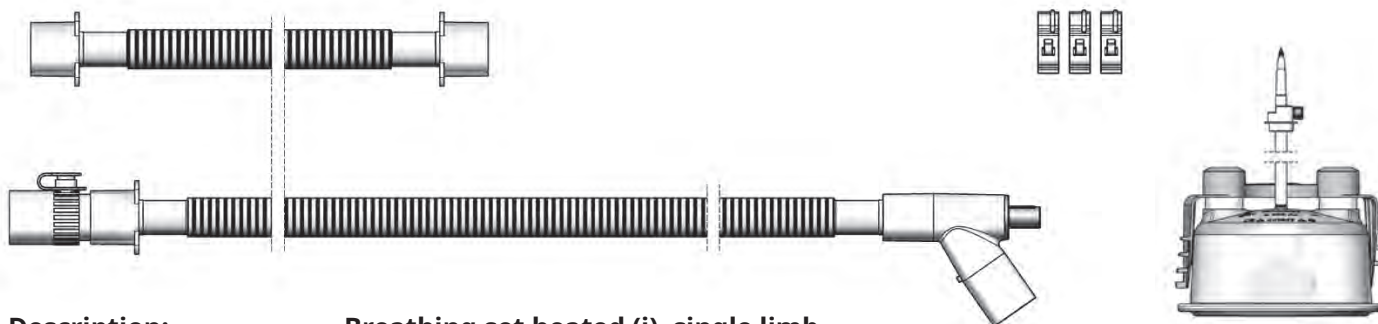

Description: **Breathing set heated (i), single limb**
 Valve: N/A
 Diameter: 15 mm
 Length: 150 cm heated
 Flow range: 3 - 30 l/min
 Connecting tube: 60 cm
 Humidification chamber: C200AF Auto-fill, only suitable for use with **AIRcon Gen2**
 Service life: Disposable system, max. 7 days

Children



Item	Part number	QTY
BTS2171A, Breathing set heated, incl. AF humidification chamber	27151910	10

For use with Resmed Astral ventilators

Breathing set heated, single limb with active valve

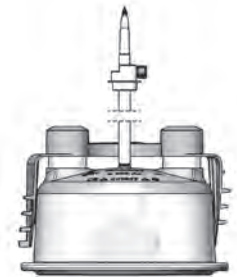
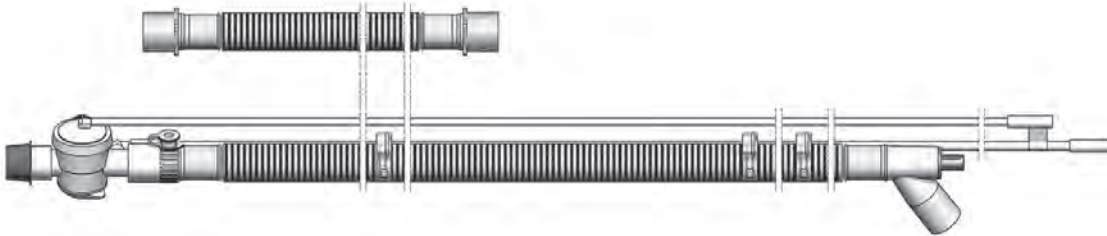

Description:

Valve: Active valve with pressure and control line
 Diameter: 22 mm
 Length: 150 cm heated
 Flow range: 4 - 80 l/min
 Connecting tube: 60 cm
 Humidification chamber: C200AF Auto-fill, only suitable for use with **AIRcon Gen2**
 Service life: Disposable system, max. 7 days

Breathing set heated (i), single limb

Adults



Item	Part number	QTY
BTS3391A, Breathing set heated, incl. AF humidification chamber	27125010	10

Breathing set heated, single limb with active valve

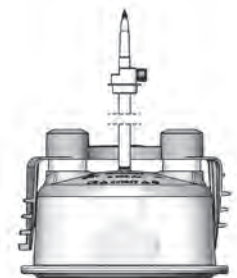
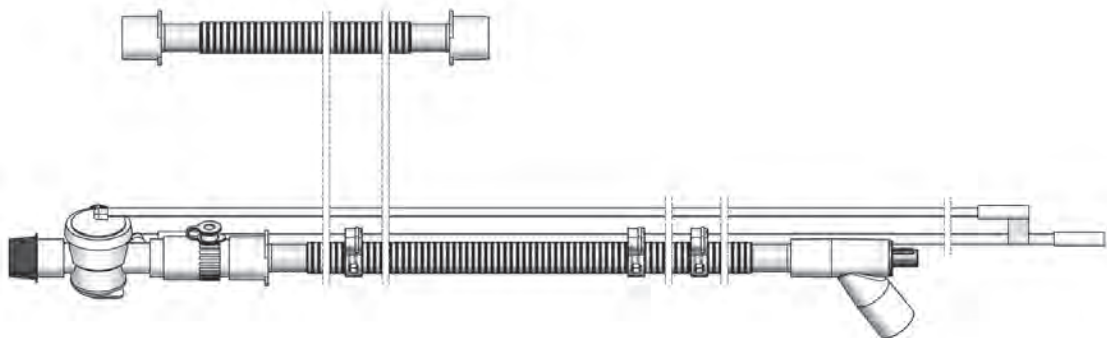

Description:

Valve: Active valve with pressure and control line
 Diameter: 15 mm
 Length: 150 cm heated
 Flow range: 3 - 30 l/min
 Connecting tube: 60 cm
 Humidification chamber: C200AF Auto-fill, only suitable for use with **AIRcon Gen2**
 Service life: Disposable system, max. 7 days

Breathing set heated (i), single limb

Children



Item	Part number	QTY
BTS2200A, Breathing set heated, incl. AF humidification chamber	27125210	10



Breathing set heated, dual limb with Y-piece

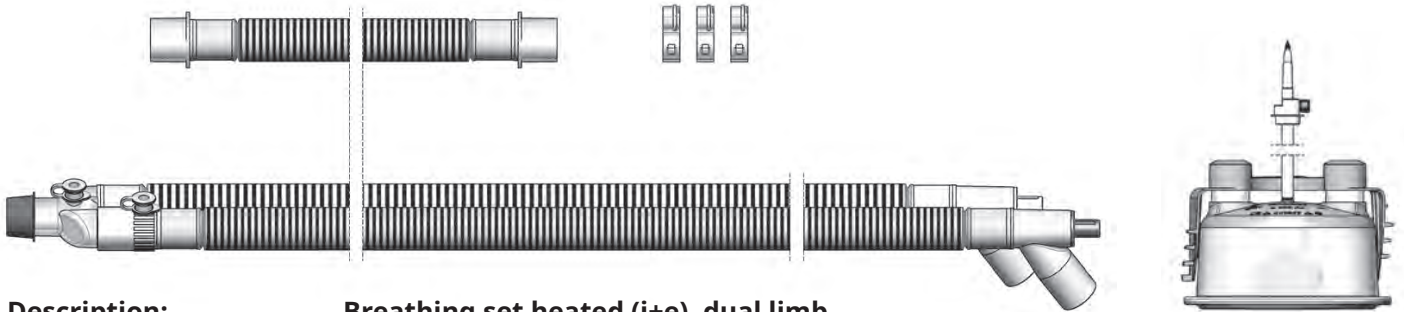

Description: Breathing set heated (i+e), dual limb
Y-piece

Diameter: 22 mm
Length: 150 cm heated
Flow range: 4 - 80 l/min
Connecting tube: 60 cm
Humidification chamber: C200AF Auto-fill, only suitable for use with **AIRcon Gen2**
Service life: Disposable system, max. 7 days



Item	Part number	QTY
BTS3167A, Breathing set heated, incl. AF humidification chamber	27176010	10

Breathing set heated, dual limb with Y-piece

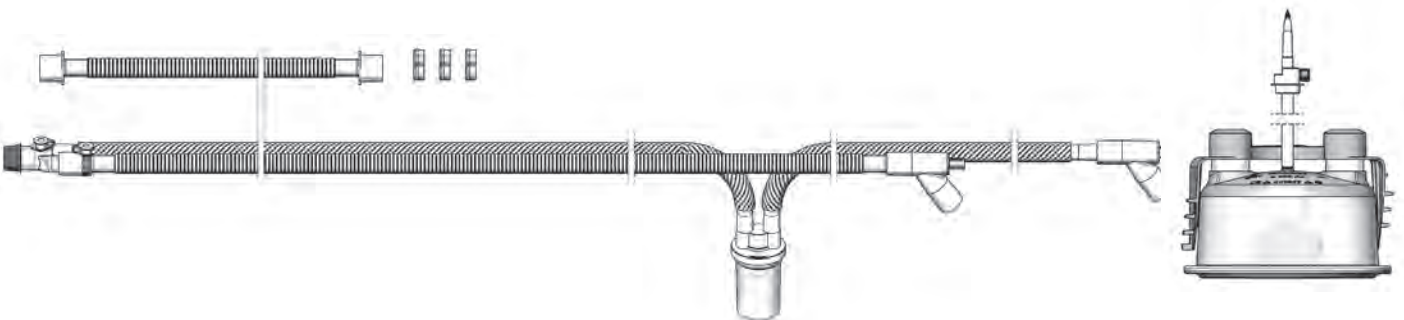

Description: Breathing set heated (i+e), dual limb with water trap
Y-piece

Diameter: 15 mm
Length: 150 cm heated
Flow range: 3 - 30 l/min
Connecting tube: 60 cm
Humidification chamber: C200AF Auto-fill, only suitable for use with **AIRcon Gen2**
Service life: Disposable system, max. 7 days



Item	Part number	QTY
BTS6038A, Breathing set heated, incl. AF humidification chamber	27150810	10

Breathing set heated, single limb with passive valve WILAsilent 2

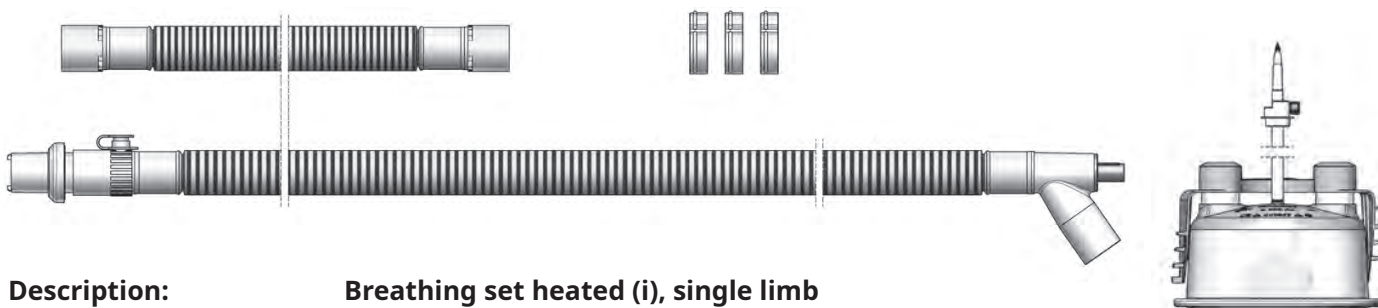

Description: **Breathing set heated (i), single limb**
 Valve: Passive valve WILAsilent 2 attached
 Diameter: 22 mm
 Length: 150 cm heated
 Flow range: 4 - 80 l/min
 Connecting tube: 60 cm
 Humidification chamber: C200AF Auto-fill, only suitable for use with **AIRcon Gen2**
 Service life: Disposable system, max. 7 days



Item	Part number	QTY
BTS3268A, Breathing set heated, incl. AF humidification chamber	27115610	10

Breathing set heated, single limb for vented masks and high-flow therapy

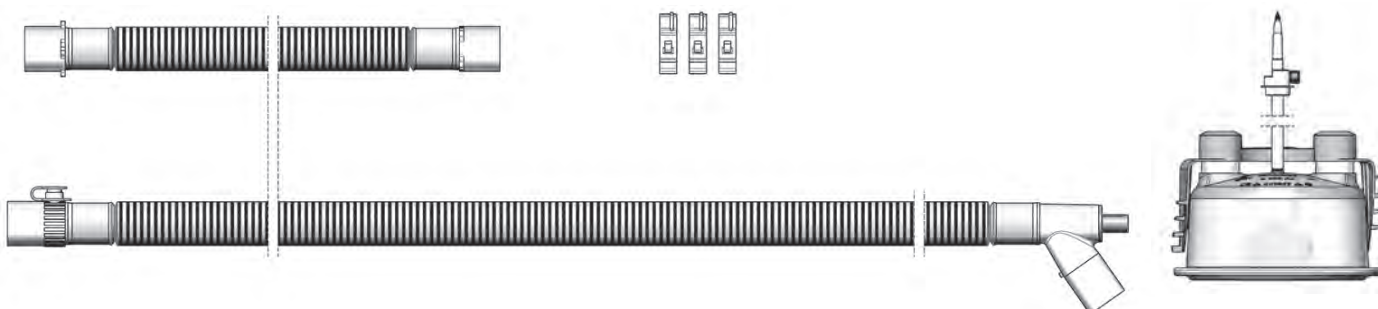

Description: **Breathing set heated (i), single limb**
 Valve: N/A
 Diameter: 22 mm
 Length: 150 cm heated
 Flow range: 4 - 80 l/min
 Connecting tube: 60 cm
 Humidification chamber: C200AF Auto-fill, only suitable for use with **AIRcon Gen2**
 Service life: Disposable system, max. 7 days



Item	Part number	QTY
BTS3234A, Breathing set heated, incl. AF humidification chamber	27112510	10



Breathing set heated, single limb with passive valve WILAsilent 2

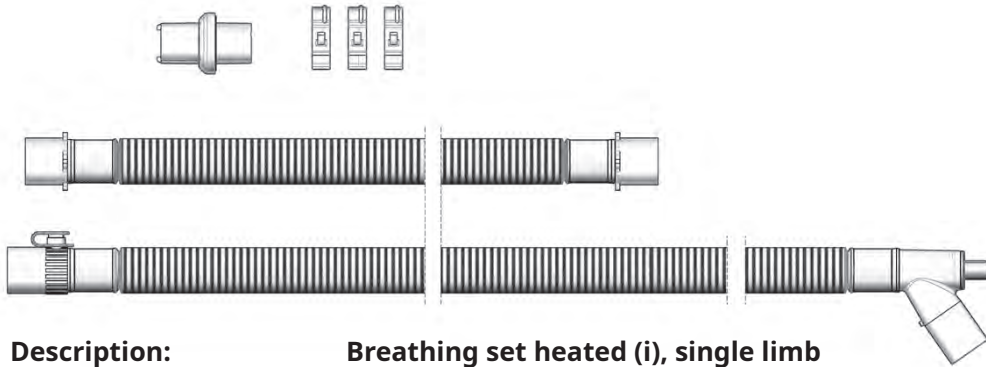

Description:
 Valve: Passive valve WILAsilent 2 included
 Diameter: 22 mm
 Length: 150 cm heated
 Flow range: 4 - 80 l/min
 Connecting tube: 60 cm
 Humidification chamber: C200AF Auto-fill universal, only suitable for use with **AIRniva**
 Service life: Disposable system, max. 7 days



Item	Part number	QTY
BTS8099A, Breathing set heated, incl. AF humidification chamber	27170510	10

Breathing set heated, single limb with passive valve WILAsilent 2

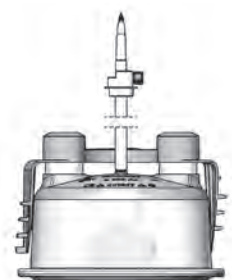
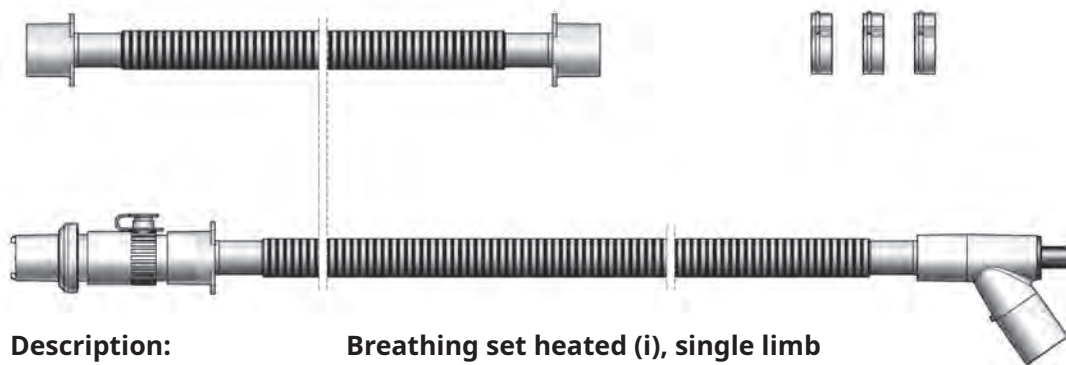

Description:
 Valve: Passive valve WILAsilent 2 attached
 Diameter: 15 mm
 Length: 150 cm heated
 Flow range: 3 - 30 l/min
 Connecting tube: 60 cm
 Humidification chamber: C200AF Auto-fill, only suitable for use with **AIRcon Gen2**
 Service life: Disposable system, max. 7 days



Item	Part number	QTY
BTS2142A, Breathing set heated, incl. AF humidification chamber	27115710	10

Breathing set heated, single limb for vented masks and high-flow therapy

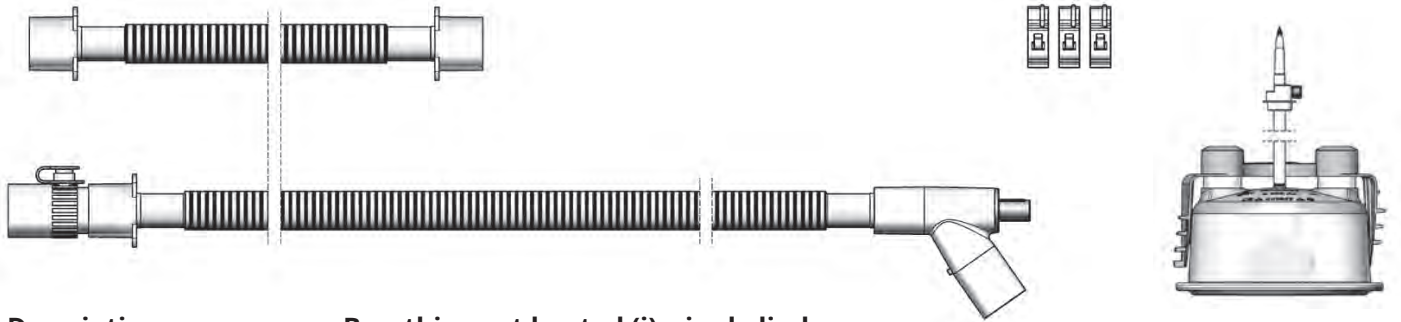

Description:

Valve:	N/A
Diameter:	15 mm
Length:	150 cm heated
Flow range:	3 - 30 l/min
Connecting tube:	60 cm
Humidification chamber:	C200AF Auto-fill, only suitable for use with AIRcon Gen2
Service life:	Disposable system, max. 7 days

Breathing set heated (i), single limb

Children



Item	Part number	QTY
BTS2171A, Breathing set heated, incl. AF humidification chamber	27151910	10



For use with Trilogy EVO ventilators

Breathing set heated, single limb with active valve

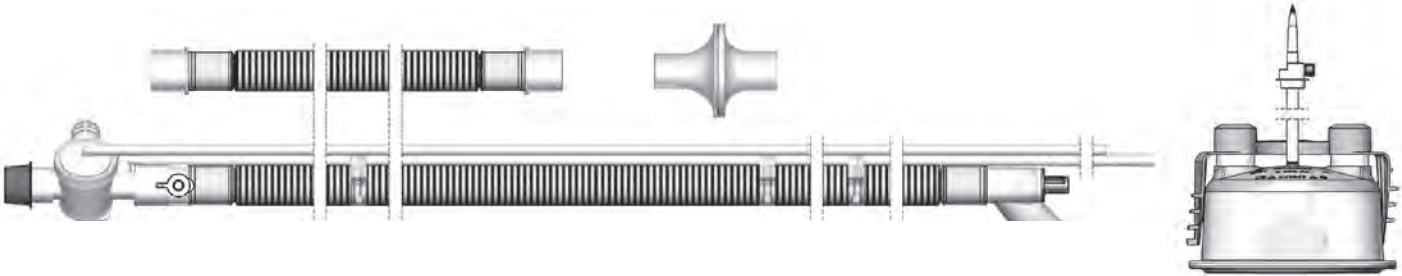

Description: **Breathing set heated (i), single limb**
 Valve: Active valve with pressure and control line
 Diameter: 22 mm
 Length: 150 cm heated
 Flow range: 4 - 80 l/min
 Connecting tube: 60 cm
 Humidification chamber: C200AF Auto-fill, only suitable for use with **AIRcon Gen2**
 Service life: Disposable system, max. 7 days



Item	Part number	QTY
BTS8074A, Breathing set heated, incl. AF humidification chamber	27168510	10

Breathing set heated, single limb with active valve

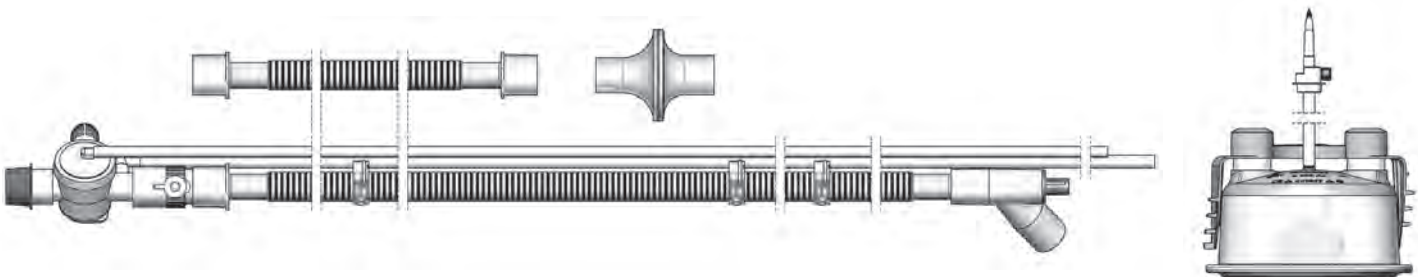

Description: **Breathing set heated (i), single limb**
 Valve: Active valve with pressure and control line
 Diameter: 15 mm
 Length: 150 cm heated
 Flow range: 3 - 30 l/min
 Connecting tube: 60 cm
 Humidification chamber: C200AF Auto-fill, only suitable for use with **AIRcon Gen2**
 Service life: Disposable system, max. 7 days



Item	Part number	QTY
BTS6054A, Breathing set heated, incl. AF humidification chamber	27168410	10

Breathing set heated, dual limb with Y-piece

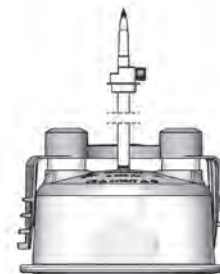
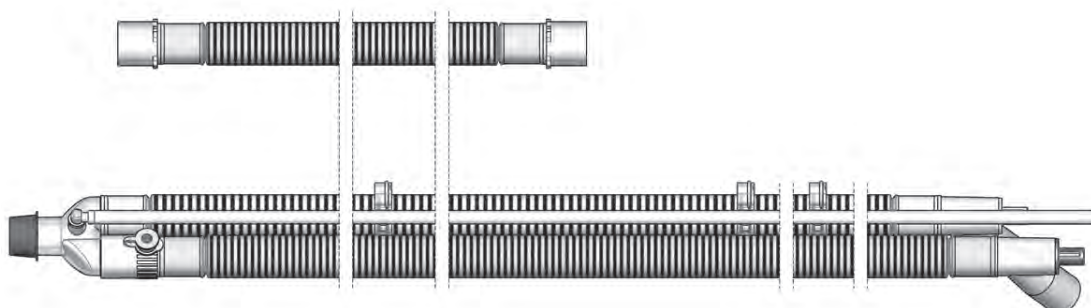

Description:

Breathing set heated (i+e), dual limb

Y-piece with pressure line
 Diameter: 22 mm
 Length: 150 cm heated
 Flow range: 4 - 80 l/min
 Connecting tube: 60 cm
 Humidification chamber: C200AF Auto-fill, only suitable for use with **AIRcon Gen2**
 Service life: Disposable system, max. 7 days

Adults



Item	Part number	QTY
BTS8121A, Breathing set heated, incl. AF humidification chamber	27174710	10

Breathing set heated, dual limb with Y-piece

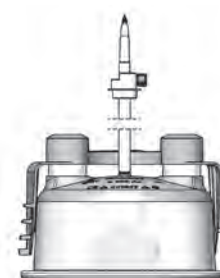
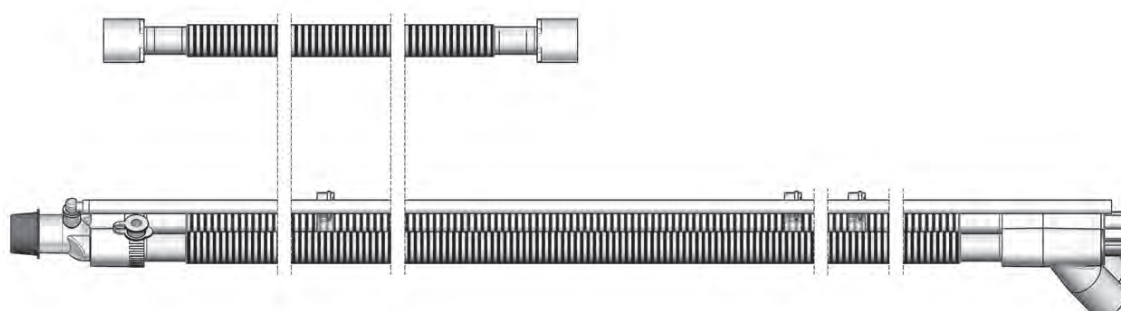

Description:

Breathing set heated (i+e), dual limb

Y-piece with pressure line
 Diameter: 15 mm
 Length: 150 cm heated
 Flow range: 3 - 30 l/min
 Connecting tube: 60 cm
 Humidification chamber: C200AF Auto-fill, only suitable for use with **AIRcon Gen2**
 Service life: Disposable system, max. 7 days

Children



Item	Part number	QTY
BTS6078A, Breathing set heated, incl. AF humidification chamber	27174610	10



Breathing set heated, single limb with passive valve WILAsilent 2

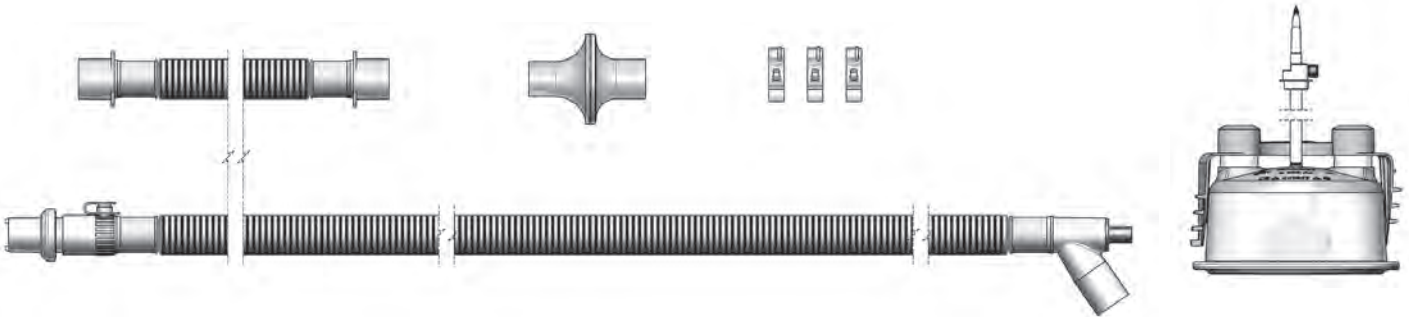

Description:
Breathing set heated (i), single limb
 Valve: Passive valve WILAsilent 2 attached
 Diameter: 22 mm
 Length: 150 cm heated
 Flow range: 4 - 80 l/min
 Connecting tube: 60 cm
 Humidification chamber: C200AF Auto-fill, only suitable for use with **AIRcon Gen2**
 Service life: Disposable system, max. 7 days



Item	Part number	QTY
BTS8071A, Breathing set heated, incl. AF humidification chamber	27168010	10

Breathing set heated, single limb with passive valve WILAsilent 2

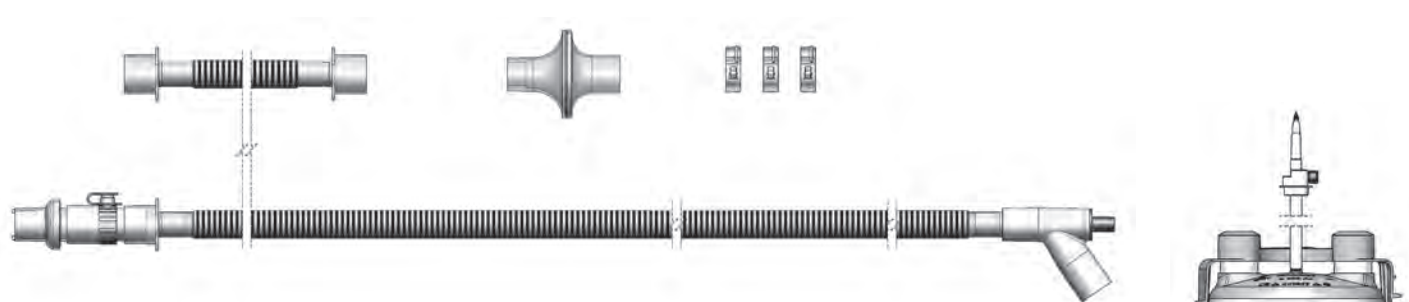

Description:
Breathing set heated (i), single limb
 Valve: Passive valve WILAsilent 2 attached
 Diameter: 15 mm
 Length: 150 cm heated
 Flow range: 3 - 30 l/min
 Connecting tube: 60 cm
 Humidification chamber: C200AF Auto-fill, only suitable for use with **AIRcon Gen2**
 Service life: Disposable system, max. 7 days



Item	Part number	QTY
BTS2247A, Breathing set heated, incl. AF humidification chamber	27168110	10

For use with LÖWENSTEIN prisma VENT50

Breathing set heated, single limb with active valve

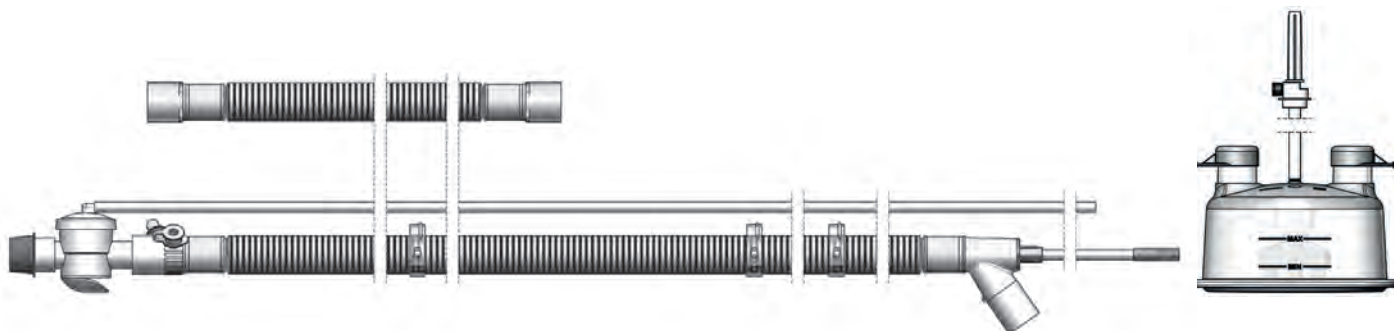

Description:
Breathing set heated (i), single limb
 Valve: Active valve with pressure and control line
 Diameter: 22 mm
 Length: 150 cm heated
 Flow range: 4 - 80 l/min
 Connecting tube: 60 cm
 Humidification chamber: C200AF Auto-fill universal, only suitable for use with **AIRniva**
 Service life: Disposable system, max. 7 days

Adults



Item	Part number	QTY
BTS8100A, Breathing set heated, incl. AF humidification chamber	27170810	10

Breathing set heated, single limb with passive valve WILAsilent 2

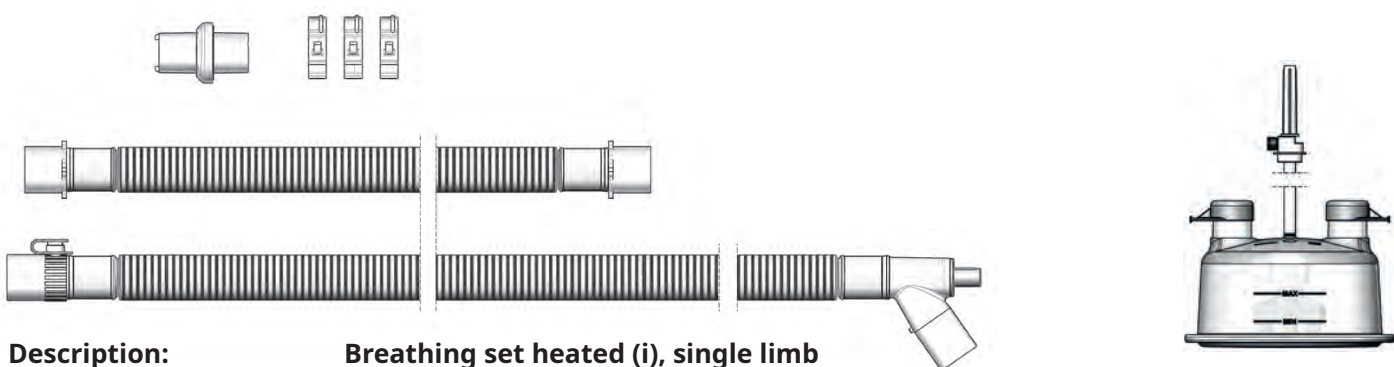

Description:
Breathing set heated (i), single limb
 Valve: Passive valve WILAsilent 2 included
 Diameter: 22 mm
 Length: 150 cm heated
 Flow range: 4 - 80 l/min
 Connecting tube: 60 cm
 Humidification chamber: C200AF Auto-fill universal, only suitable for use with **AIRniva**
 Service life: Disposable system, max. 7 days

Adults



Item	Part number	QTY
BTS8099A, Breathing set heated, incl. AF humidification chamber	27170510	10



Breathing set heated, single limb with passive valve WILAsilent 2

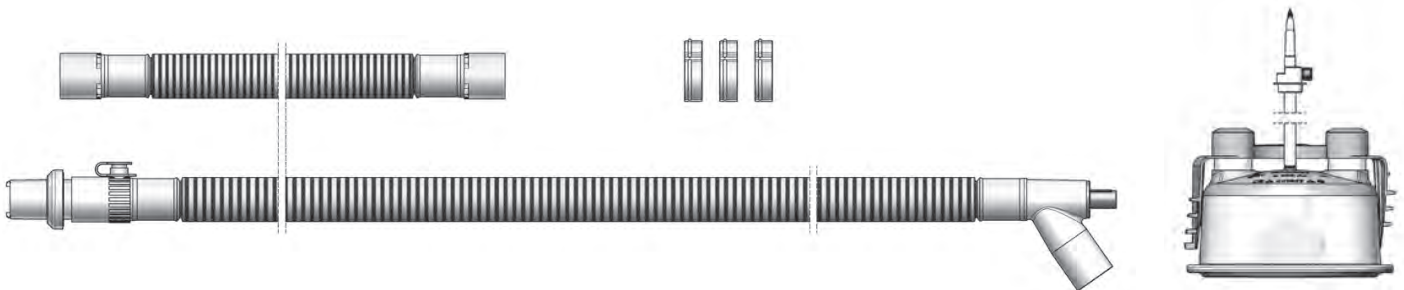

Description: **Breathing set heated (i), single limb**
 Valve: Passive valve WILAsilent 2 attached
 Diameter: 22 mm
 Length: 150 cm heated
 Flow range: 4 - 80 l/min
 Connecting tube: 60 cm
 Humidification chamber: C200AF Auto-fill, only suitable for use with **AIRcon Gen2**
 Service life: Disposable system, max. 7 days



Item	Part number	QTY
BTS3268A, Breathing set heated, incl. AF humidification chamber	27115610	10

Breathing set heated, single limb for vented masks and high-flow therapy

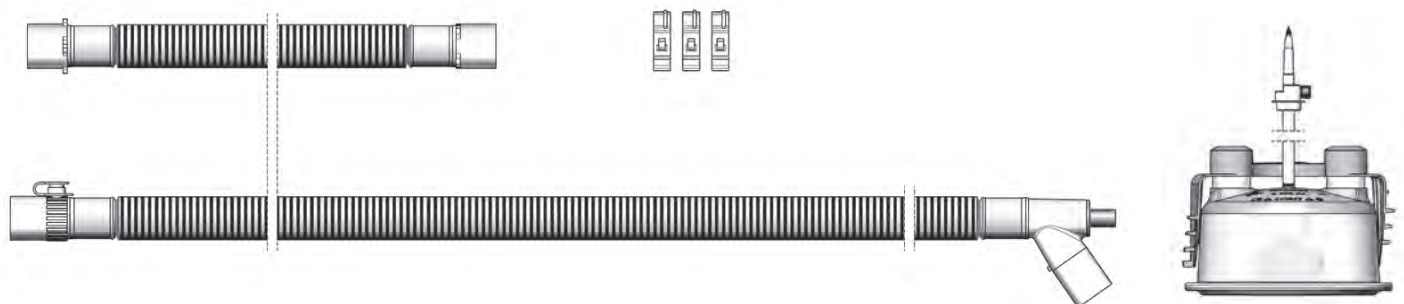

Description: **Breathing set heated (i), single limb**
 Valve: N/A
 Diameter: 22 mm
 Length: 150 cm heated
 Flow range: 4 - 80 l/min
 Connecting tube: 60 cm
 Humidification chamber: C200AF Auto-fill, only suitable for use with **AIRcon Gen2**
 Service life: Disposable system, max. 7 days



Item	Part number	QTY
BTS3234A, Breathing set heated, incl. AF humidification chamber	27112510	10

Breathing set heated, single limb with passive valve WILAsilent 2

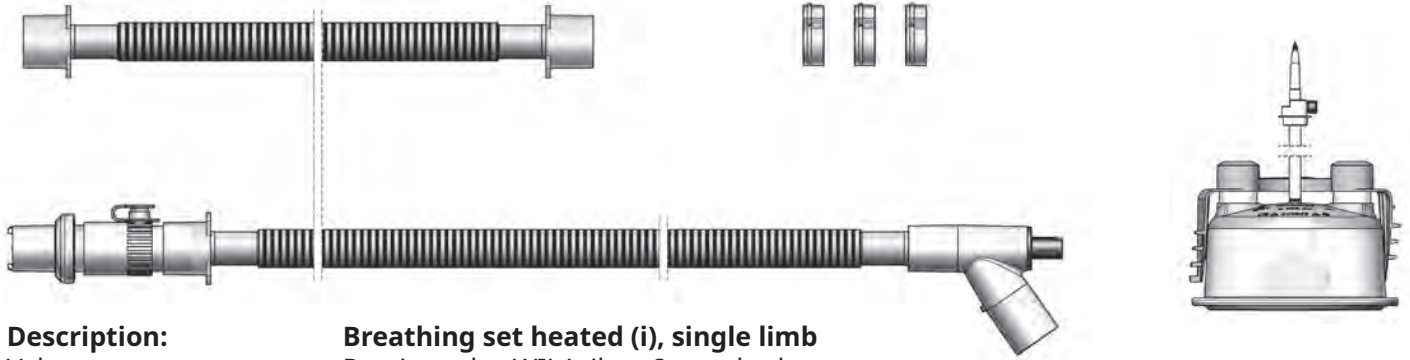

Description:
 Valve: Passive valve WILAsilent 2 attached
 Diameter: 15 mm
 Length: 150 cm heated
 Flow range: 3 - 30 l/min
 Connecting tube: 60 cm
 Humidification chamber: C200AF Auto-fill, only suitable for use with **AIRcon Gen2**
 Service life: Disposable system, max. 7 days



Item	Part number	QTY
BTS2142A , Breathing set heated, incl. AF humidification chamber	27115710	10

Breathing set heated, single limb for vented masks and high-flow therapy

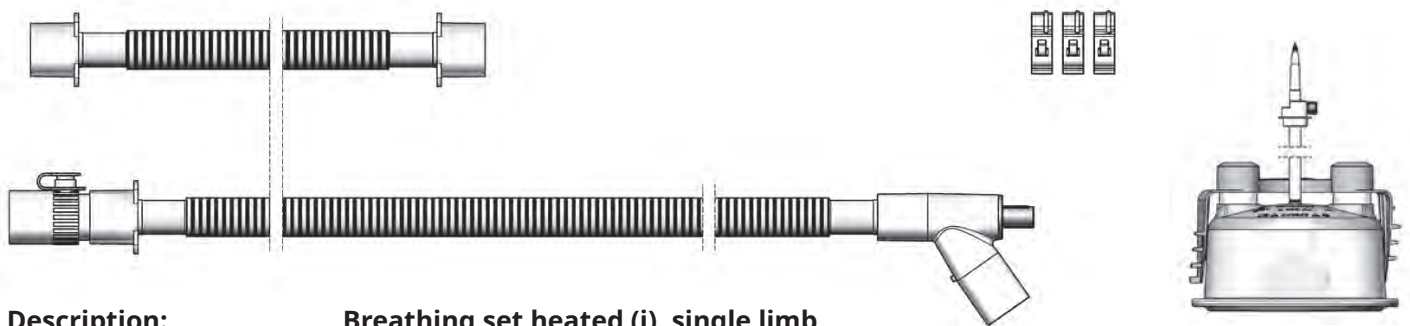

Description:
 Valve: N/A
 Diameter: 15 mm
 Length: 150 cm heated
 Flow range: 3 - 30 l/min
 Connecting tube: 60 cm
 Humidification chamber: C200AF Auto-fill, only suitable for use with **AIRcon Gen2**
 Service life: Disposable system, max. 7 days



Item	Part number	QTY
BTS2171A, Breathing set heated, incl. AF humidification chamber	27151910	10



HUMIDIFICATION CHAMBERS

The humidification chamber is an essential component of our heated ventilation sets, so the two are also perfectly matched.

Thus, we ensure optimal respiratory gas conditioning for mechanically ventilated patients, both in clinical and non-clinical settings.

The C200AF Auto-Fill humidification chambers guarantee a constant water level, on the one hand due to our sophisticated float set inside the chamber and on the other hand due to the highly precise infrared water level monitoring of the AIRcon.

Our humidification chambers can be ordered individually or as part of a complete ventilation set (convenience kit).

With our sterile water „WILaqua“ we can offer a closed set completely from one source.

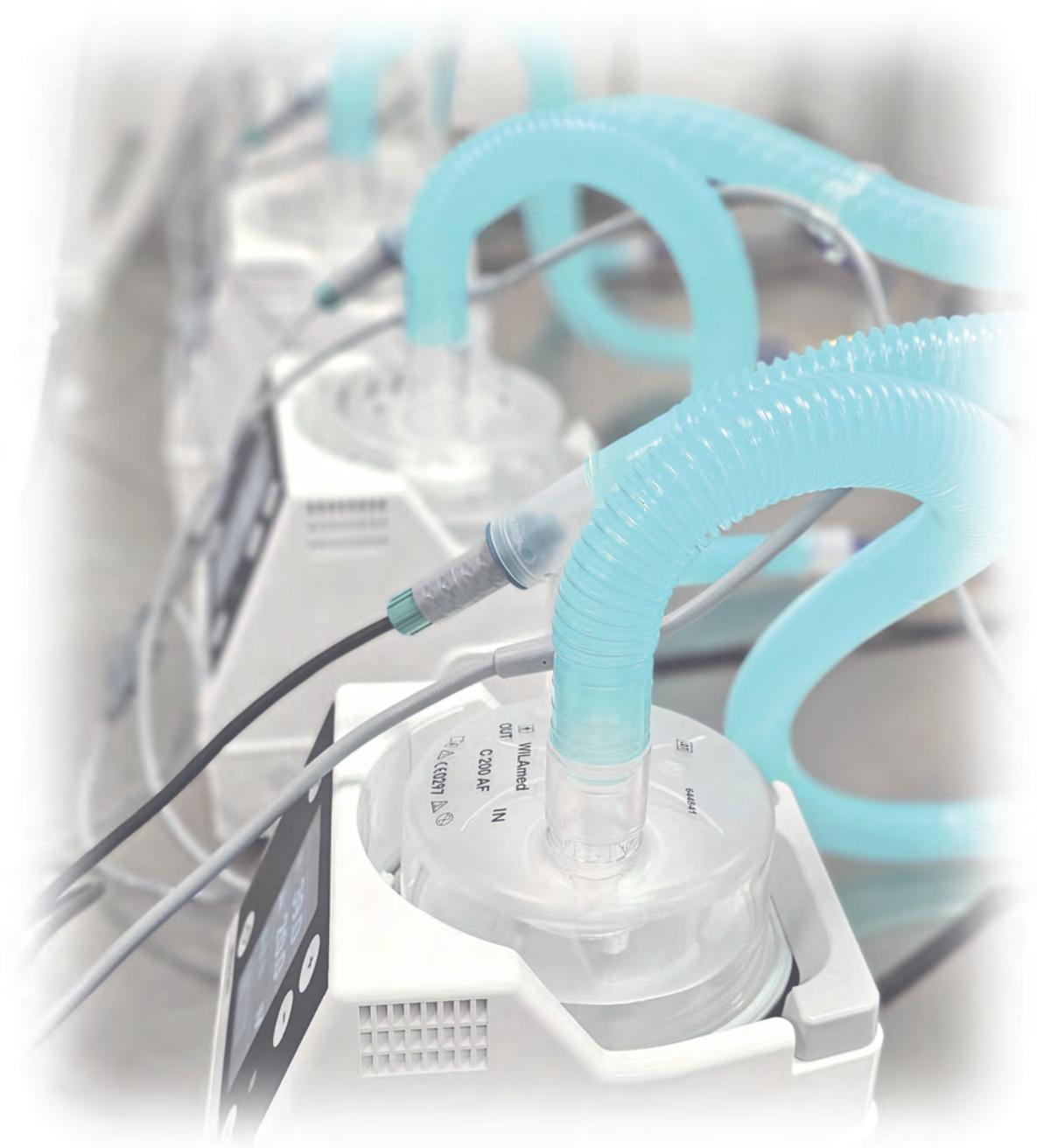

C200AF AIRcon humidifier chamber



Auto-Fill humidifier chamber, for all patient groups.
For use with AIRcon respiratory gas humidifiers only.

Item	Part number	QTY
C200AF Auto-Fill humidifier chamber for AIRcon	50030030	30

C200AF Universal humidifier chamber



Auto-Fill humidifier chamber for all patient groups.
For use with AIRniva respiratory gas humidifiers.

Item	Part number	QTY
C200AF Auto-Fill Universal Humidifier Chamber	50038030	30



BREATHING SETS UNHEATED

For use with LÖWENSTEIN LUISA

Breathing set unheated, single limb with active valve

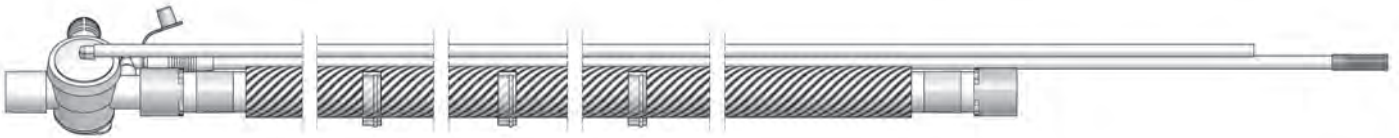

Description:

Breathing set unheated, single limb
Valve: Active valve with pressure and control line
Diameter: 22 mm
Length: 180 cm
Flow range: 4 - 80 l/min
Service life: Disposable system, max. 7 days



Item	Part number	QTY
BTS8116, Breathing set unheated	27173310	10

Breathing set unheated, single limb with active valve

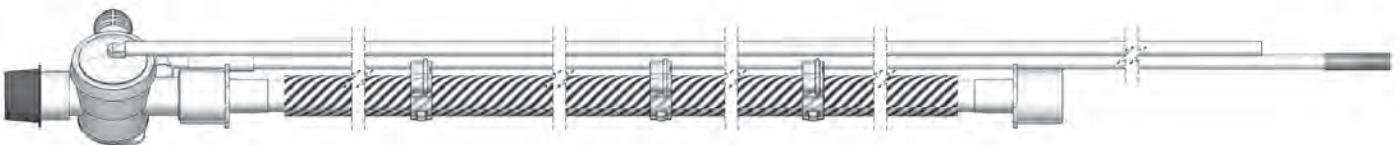

Description:

Breathing set unheated, single limb
Valve: Active valve with pressure and control line
Diameter: 15 mm
Length: 150 cm
Flow range: 3 - 30 l/min
Service life: Disposable system, max. 7 days



Item	Part number	QTY
BTS6074, Breathing set unheated	27173410	10

Breathing set unheated, dual limb with Y-piece

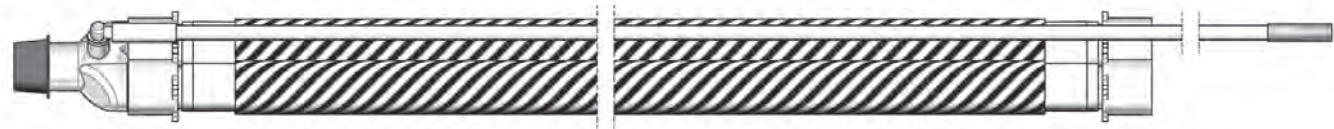

Description: Breathing set unheated, dual limb
Y-piece with pressure line

Diameter: 22 mm
Length: 180 cm
Flow range: 4 - 80 l/min
Service life: Disposable system, max. 7 days



Item	Part number	QTY
BTS8118, Breathing set unheated	27173710	10

Breathing set unheated, dual limb with Y-piece



Description: Breathing set unheated, dual limb
Y-piece with pressure line

Diameter: 15 mm
Length: 150 cm
Flow range: 3 - 30 l/min
Service life: Disposable system, max. 7 days



Item	Part number	QTY
BTS6073, Breathing set unheated	27173210	10



Breathing set unheated, dual limb with Y-piece

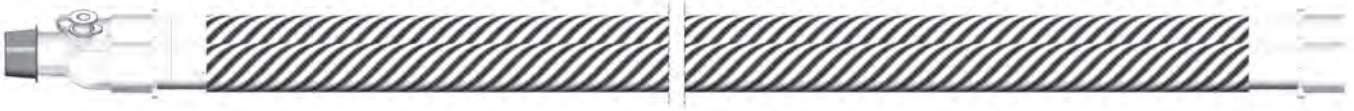

Description: Breathing set unheated, dual limb
Y-piece
Diameter: 22 mm
Length: 180 cm
Flow range: 4 - 80 l/min
Service life: Disposable system, max. 7 days

Adults



Item	Part number	QTY
BTS300, Breathing set unheated	27100310	10

Breathing set unheated, dual limb with Y-piece

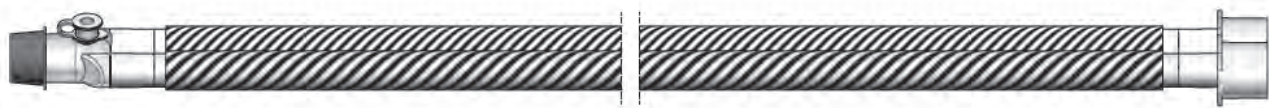

Description: Breathing set unheated, dual limb
Y-piece
Diameter: 15 mm
Length: 150 cm
Flow range: 3 - 30 l/min
Service life: Disposable system, max. 7 days

Children



Item	Part number	QTY
BTS2259, Breathing set unheated	27175710	10

Breathing set unheated, single limb with passive valve WILAsilent 2



Description:

Valve: Passive valve WILAsilent 2 included
Diameter: 22 mm
Length: 180 cm
Flow range: 4 - 80 l/min
Service life: Disposable system, max. 7 days

Adults



Item	Part number	QTY
BTS8167, Breathing set unheated	27178910	10

Breathing set unheated, single limb with passive valve WILAsilent 2

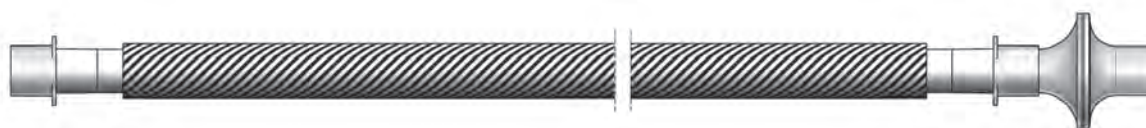

Description:

Valve: Passive valve WILAsilent 2 included
Diameter: 22 mm
Length: 180 cm
Flow range: 4 - 80 l/min
Service life: Disposable system, max. 7 days

Adults



Item	Part number	QTY
BTS8072, Breathing set unheated	27167910	10



Breathing set unheated, single limb with passive valve WILAsilent 2



Description: **Breathing set unheated, single limb**
 Valve: Passive valve WILAsilent 2 included
 Diameter: 15 mm
 Length: 150 cm
 Flow range: 3 - 30 l/min
 Service life: Disposable system, max. 7 days

Children



Item	Part number	QTY
BTS6091, Breathing set unheated	27178810	10

Breathing set unheated, single limb with passive valve WILAsilent 2



Description: **Breathing set unheated, single limb, including bacteria/virus filter**
 Valve: Passive valve WILAsilent 2 included
 Diameter: 15 mm
 Length: 150 cm
 Flow range: 3 - 30 l/min
 Service life: Disposable system, max. 7 days

Children



Item	Part number	QTY
BTS6053, Breathing set unheated	27167810	10



For use with Breas Vivo 45LS/55 and Vivo 65 ventilators

Breathing set unheated, single limb with active valve

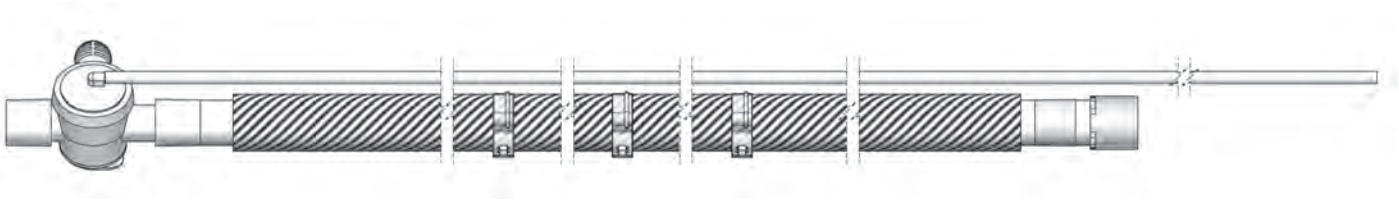

Description: **Breathing set unheated, single limb**
 Valve: Active valve with control line
 Diameter: 22 mm
 Length: 180 cm
 Flow range: 4 - 80 l/min
 Service life: Disposable system, max. 7 days

Adults



Item	Part number	QTY
BTS3172, Breathing set unheated	27068510	10

Breathing set unheated, single limb with active valve

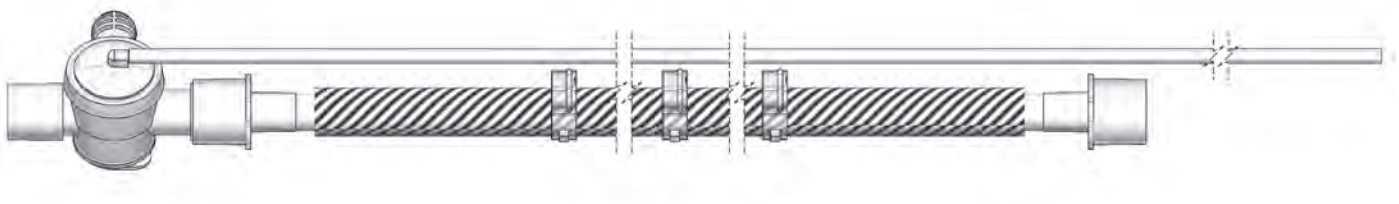

Description: **Breathing set unheated, single limb**
 Valve: Active valve with control line
 Diameter: 15 mm
 Length: 150 cm
 Flow range: 3 - 30 l/min
 Service life: Disposable system, max. 7 days

Children



Item	Part number	QTY
BTS2127, Breathing set unheated	27113610	10



Breathing set unheated, dual limb with Y-piece (only for Vivo 65)

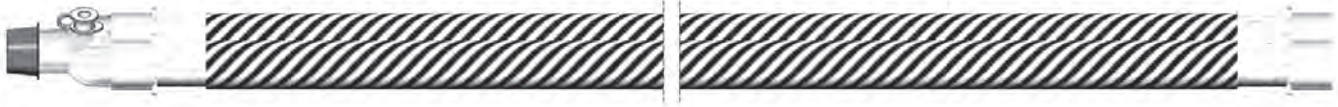

Description: Breathing set unheated, dual limb
Y-piece
Diameter: 22 mm
Length: 180 cm
Flow range: 4 - 80 l/min
Service life: Disposable system, max. 7 days

Adults



Item	Part number	QTY
BTS300 - Breathing set unheated	27100310	10

Breathing set unheated, dual limb with Y-piece (only for Vivo 65)



Description: Breathing set unheated, dual limb
Y-piece
Diameter: 15 mm
Length: 150 cm
Flow range: 3 - 30 l/min
Service life: Disposable system, max. 7 days

Children



Item	Part number	QTY
BTS200 - Breathing set unheated	27032910	10

Breathing set unheated, single limb with passive valve WILAsilent 2

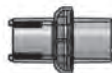

Description: **Breathing set unheated, single limb**
 Valve: Passive valve WILAsilent 2 included
 Diameter: 22 mm
 Length: 180 cm
 Flow range: 4 - 80 l/min
 Service life: Disposable system, max. 7 days

Adults



Item	Part number	QTY
BTS8167, Breathing set unheated	27178910	10

Breathing set unheated, single limb with passive valve WILAsilent 2

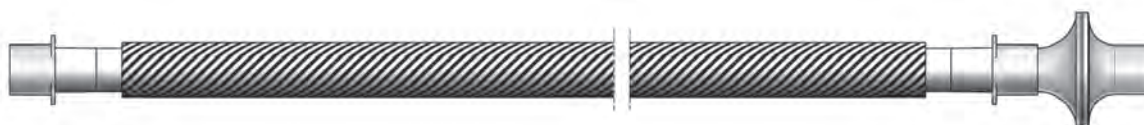

Description: **Breathing set unheated, single limb, including bacteria/virus filter**
 Valve: Passive valve WILAsilent 2 included
 Diameter: 22 mm
 Length: 180 cm
 Flow range: 4 - 80 l/min
 Service life: Disposable system, max. 7 days

Adults



Item	Part number	QTY
BTS8072, Breathing set unheated	27167910	10



Breathing set unheated, single limb with passive valve WILAsilent 2



Description:
 Valve: Passive valve WILAsilent 2 included
 Diameter: 15 mm
 Length: 150 cm
 Flow range: 3 - 30 l/min
 Service life: Disposable system, max. 7 days

Children



Item	Part number	QTY
BTS6091, Breathing set unheated	27178810	10

Breathing set unheated, single limb with passive valve WILAsilent 2



Description:
 Valve: Passive valve WILAsilent 2 included
 Diameter: 15 mm
 Length: 150 cm
 Flow range: 3 - 30 l/min
 Service life: Disposable system, max. 7 days

Children



Item	Part number	QTY
BTS6053, Breathing set unheated	27167810	10



For use with Resmed Astral ventilators

Breathing set unheated, single limb with active valve

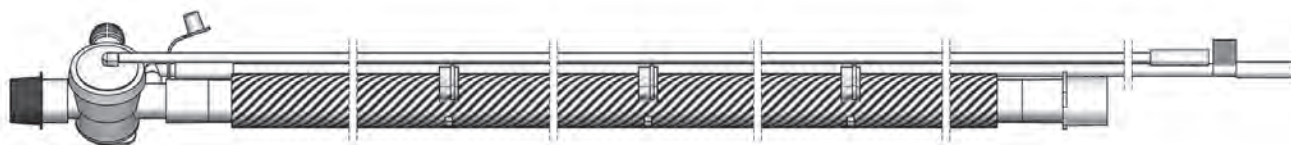

Description:

Valve: Active valve with pressure and control line
Diameter: 22 mm
Length: 180 cm
Flow range: 4 - 80 l/min
Service life: Disposable system, max. 7 days

Breathing set unheated, single limb

Active valve with pressure and control line
22 mm
180 cm
4 - 80 l/min
Disposable system, max. 7 days

Adults



Item	Part number	QTY
BTS3390, Breathing set unheated	27124910	10

Breathing set unheated, single limb with active valve

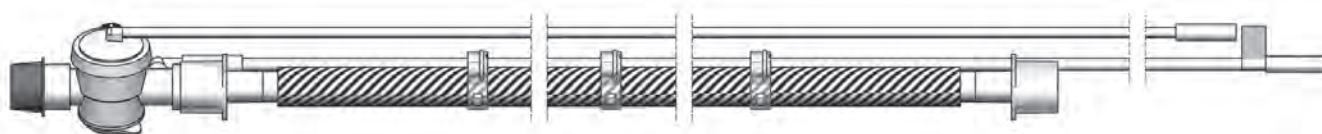

Description:

Valve: Active valve with pressure and control line
Diameter: 15 mm
Length: 150 cm
Flow range: 3 - 30 l/min
Service life: Disposable system, max. 7 days

Breathing set unheated, single limb

Active valve with pressure and control line
15 mm
150 cm
3 - 30 l/min
Disposable system, max. 7 days

Children



Item	Part number	QTY
BTS2199 - Breathing set unheated	27125110	10



Breathing set unheated, dual limb with Y-piece

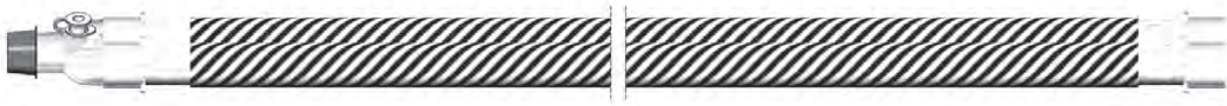

Description: Breathing set unheated, dual limb
Y-piece
Diameter: 22 mm
Length: 180 cm
Flow range: 4 - 80 l/min
Service life: Disposable system, max. 7 days



Item	Part number	QTY
BTS300 - Breathing set unheated	27100310	10

Breathing set unheated, dual limb with Y-piece



Description: Breathing set unheated, dual limb
Y-piece
Diameter: 15 mm
Length: 150 cm
Flow range: 3 - 30 l/min
Service life: Disposable system, max. 7 days



Item	Part number	QTY
BTS200 - Breathing set unheated	27032910	10

Breathing set unheated, single limb with passive valve WILAsilent 2



Description: **Breathing set unheated, single limb**
 Valve: Passive valve WILAsilent 2 included
 Diameter: 22 mm
 Length: 180 cm
 Flow range: 4 - 80 l/min
 Service life: Disposable system, max. 7 days



Item	Part number	QTY
BTS8167, Breathing set unheated	27178910	10

Breathing set unheated, single limb with passive valve WILAsilent 2

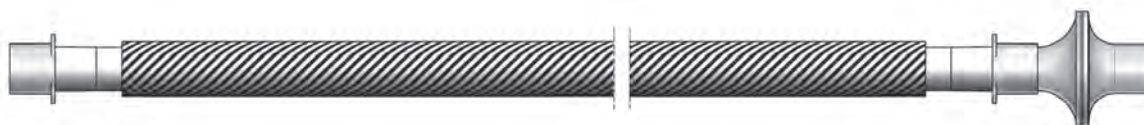

Description: **Breathing set unheated, single limb, including bacteria/virus filter**
 Valve: Passive valve WILAsilent 2 included
 Diameter: 22 mm
 Length: 180 cm
 Flow range: 4 - 80 l/min
 Service life: Disposable system, max. 7 days



Item	Part number	QTY
BTS8072, Breathing set unheated	27167910	10



Breathing set unheated, single limb with passive valve WILAsilent 2



Description: **Breathing set unheated, single limb**
 Valve: Passive valve WILAsilent 2 included
 Diameter: 15 mm
 Length: 150 cm
 Flow range: 3 - 30 l/min
 Service life: Disposable system, max. 7 days

Children



Item	Part number	QTY
BTS6091, Breathing set unheated	27178810	10

Breathing set unheated, single limb with passive valve WILAsilent 2

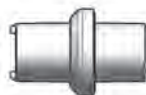

Description: **Breathing set unheated, single limb, including bacteria/virus filter**
 Valve: Passive valve WILAsilent 2 included
 Diameter: 15 mm
 Length: 150 cm
 Flow range: 3 - 30 l/min
 Service life: Disposable system, max. 7 days

Children



Item	Part number	QTY
BTS6053, Breathing set unheated	27167810	10



For use with LÖWENSTEIN prisma VENT50

Breathing set unheated, single limb with active valve



Description:

Valve:

Diameter:

Length:

Flow range:

Service life:

Breathing set unheated, single limb

Active valve with pressure and control line

22 mm

180 cm

4 - 80 l/min

Disposable system, max. 7 days

Adults



Item	Part number	QTY
BTS3117, Breathing set unheated	27058410	10

Breathing set unheated, single limb with active valve



Description:

Valve:

Diameter:

Length:

Flow range:

Service life:

Breathing set unheated, single limb

Active valve with pressure and control line

15 mm

150 cm

3 - 30 l/min

Disposable system, max. 7 days

Children



Item	Part number	QTY
BTS6068, Breathing set unheated	27170610	10



Breathing set unheated, single limb with passive valve WILAsilent 2

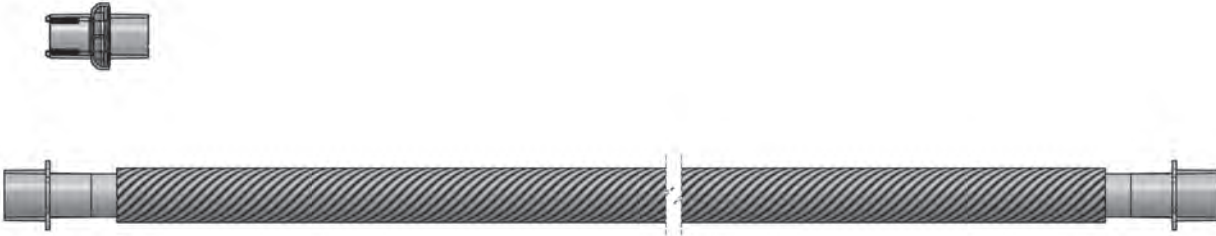

Description: **Breathing set unheated, single limb**
 Valve: Passive valve WILAsilent 2 included
 Diameter: 22 mm
 Length: 180 cm
 Flow range: 4 - 80 l/min
 Service life: Disposable system, max. 7 days



Item	Part number	QTY
BTS8167, Breathing set unheated	27178910	10

Breathing set unheated, single limb with passive valve WILAsilent 2

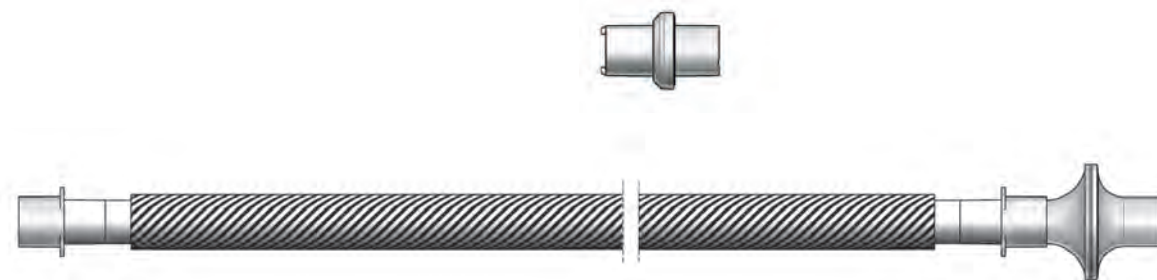

Description: **Breathing set unheated, single limb, including bacteria/virus filter**
 Valve: Passive valve WILAsilent 2 included
 Diameter: 22 mm
 Length: 180 cm
 Flow range: 4 - 80 l/min
 Service life: Disposable system, max. 7 days



Item	Part number	QTY
BTS8072, Breathing set unheated	27167910	10

Breathing set unheated, single limb with passive valve WILAsilent 2



Description: Breathing set unheated, single limb
 Valve: Passive valve WILAsilent 2 included
 Diameter: 15 mm
 Length: 150 cm
 Flow range: 3 - 30 l/min
 Service life: Disposable system, max. 7 days

Children



Item	Part number	QTY
BTS6091, Breathing set unheated	27178810	10

Breathing set unheated, single limb with passive valve WILAsilent 2



Description: Breathing set unheated, single limb, including bacteria/virus filter
 Valve: Passive valve WILAsilent 2 included
 Diameter: 15 mm
 Length: 150 cm
 Flow range: 3 - 30 l/min
 Service life: Disposable system, max. 7 days

Children



Item	Part number	QTY
BTS6053, Breathing set unheated	27167810	10



CLEARline

For use with mechanical insufflator-exsufflator (MI-E)
LÖWENSTEIN CARO, PHILIPS RESPIRONICS Cough Assist E70

Breathing set unheated, single limb



Description: Breathing set unheated, single limb
for mechanical insufflator-exsufflator (MI-E)
Diameter: 22 mm with smooth lumen
Length: 180 cm
Service life: Disposable system, max. 7 days



Item	Part number	QTY
BTS3301, Breathing set unheated	27093110	10

Breathing set unheated, single limb

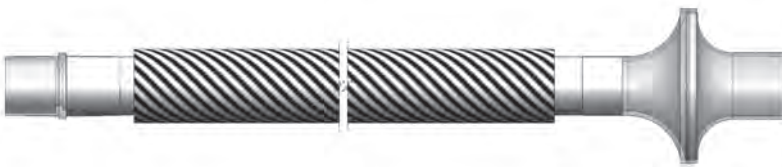

Description: Breathing set unheated, single limb
for mechanical insufflator-exsufflator (MI-E)
Diameter: 22 mm with smooth lumen
Length: 90 cm
Service life: Disposable system, max. 7 days



Item	Part number	QTY
BTS834, Breathing set unheated	27119110	10



DISPOSABLE PATIENT INTERFACES

High flow nasal cannulas

* Only available in selected markets.
Contact us for further information.



Specifically designed for Nasal High Flow Therapy, the nasal cannula allows delivery of flow rates up to 80 liters per minute. Its compact, flexible design, together with its light weight and low noise, provides maximum patient comfort.

Item	Part number	QTY
High flow nasal cannula, size S	20123310	10
High flow nasal cannula, size M	20123410	10
High flow nasal cannula, size L	20123510	10

LMFlo2 High-Flow Nasal Cannulas

* Only available in selected markets.
Contact us for further information.



WILMed offers a wide range of nasal cannulae for use in nasal high-flow oxygen therapy: from low flow rates when ventilating the smallest patients to very high flow rates for adults.

Item	Part number	QTY
LMFlo2 High-Flow Nasal Cannula, Size S (Adult)	201230	10
LMFlo2 High-Flow Nasal Cannula, Size M (Adult)	201231	10
LMFlo2 High-Flow Nasal Cannula, Size L (Adult)	201232	10



Catheter Mount



Tube extension with angled double rotary connector and suction bronchoscopy opening. Fits all common endotracheal tubes, laryngeal masks and laryngeal tubes.

Item	Part number	QTY
Catheter Mount, 20 cm, 22M/15F-22F	270103131	31
Catheter Mount, 20 cm, 22M/15F-15M	270500131	31
Catheter Mount, 15 cm, 22M/15F-22F	270501131	31
Catheter Mount, 15 cm, 22M/15F-15M	270102131	31

CozyLine & CozyTube

Discover the latest standard in PAP respiratory therapy with our heated breathing tube for both pediatric and adult patients.

The embedded spiral heating wire ensures consistent temperature and humidity levels while effectively minimizing condensation.

The smooth inner lumen guarantees an unobstructed airflow, allowing you to focus entirely on your therapy.



CozyLine (with power supply unit)

Item	Part number	QTY
BT3489, CozyTube breathing tube heated with power supply unit, 180cm, 15 Ø	271072	1
BT3491, CozyTube breathing tube heated with power supply unit, 180cm, 19 Ø	271073	1

CozyTube (without power supply unit)

Item	Part number	QTY
BT2634, CozyTube breathing tube heated, 180cm, 15 Ø	2700621	1
BT2630, CozyTube breathing tube heated, 180cm, 19 Ø	2700631	1



AIRline CPAP

Our high-quality AIRline CPAP breathing tube for sleep therapy is the result of cutting-edge technology combined with premium materials.

With an inner diameter of 15 mm or 19 mm, it enables optimal airflow while minimizing resistance thanks to “Smoothbore” technology. This maximizes the efficiency of sleep therapy, reduces noise levels, and contributes to a restful night’s sleep.

The AIRline CPAP breathing tube is compatible with all common CPAP devices and masks, ensuring seamless integration into existing therapy.



Item	Part number	QTY
BT2100, Breathing tube, unheated - Ø15 mm, 180 cm	2704461	1
BT3314, Breathing tube, unheated - Ø19 mm, 30 cm	2701551	1
BT3307, Breathing tube, unheated - Ø19 mm, 60 cm	2701531	1
BT3320, Breathing tube, unheated - Ø19 mm, 75 cm	2700531	1
BT3800, Breathing tube, unheated - Ø19 mm, 90 cm	2700021	1
BT3304, Breathing tube, unheated - Ø19 mm, 120 cm	2701461	1
BT3291, Breathing tube, unheated - Ø19 mm, 150 cm	2701501	1
BT3101, Breathing tube, unheated - Ø19 mm, 180 cm	2701661	1
BT3400, Breathing tube, unheated - Ø19 mm, 200 cm	2701361	1
BT3309, Breathing tube, unheated - Ø19 mm, 270 cm	2701731	1
BT2638, Breathing tube, unheated, black - Ø19 mm, 60 cm	2701511	1
BT2637, Breathing tube, unheated, black - Ø19 mm, 180 cm	2701663	1

NEW

Cirri mini nasal masks with headstrap



Cirri mini nasal masks are made of soft silicone.

- CPAP and NV versions, each available in 4 sizes
- Manually adjustable forehead pads
- Low weight
- High adaptability
- High freedom of movement
- Easy to clean
- Standard hose connection 360° rotatable

Item	Part number	QTY
Cirri mini CPAP nasal mask with headstrap, size: child S	201144	1
Cirri mini CPAP nasal mask with headstrap, size: child M	201145	1
Cirri mini CPAP nasal mask with headstrap, size: child L	201146	1
Cirri mini CPAP nasal mask with headstrap, size: child XL	201147	1
Cirri mini NV nasal mask with headstrap, size: child S	201140	1
Cirri mini NV nasal mask with headstrap, size: child M	201141	1
Cirri mini NV nasal mask with headstrap, size: child L	201142	1
Cirri mini NV nasal mask with headstrap, size: child XL	201143	1
Headstrap for children, size: S/M for Cirri Mini Mask	201148	1
Headstrap for children, size: L/XL for Cirri Mini Mask	201149	1



HEAD GEAR FOR PATIENT INTERFACES

Headstrap: DALLAS



Item	Part number	QTY
Cap DALLAS, Navy Blue, Size M	300012	1
Cap DALLAS, Navy Blue, Size L	300013	1

Headstrap: NEW YORK



Item	Part number	QTY
Cap NEW YORK, White, Size S	300005	1
Cap NEW YORK, White, Size M	300010	1



Headstrap: RIO



Item	Part number	QTY
Cap RIO, Navy Blue, One-Size	300450	1

Chinstrap Ottawa, Toronto and Québec



Item	Part number	QTY
Chinstrap Ottawa, with mesh fabric, navy blue, one size	300316	1
Chinstrap Toronto, white, one size	300315	1
Chinstrap Québec, with mesh fabric, white, one size	300310	1



ACCESSORIES

WILAsil CPAP cleaner



Special CPAP cleaner for breathing masks, breathing tubes and accessories. Concentrate for mixing with water.

Item	Part number	QTY
WILAsil Cleaner, 250 ml (DE)	500177	9
WILAsil Cleaner, 250 ml (CH)	500178	9
WILAsil Cleaner, 250 ml (NL)	5001777	9
WILAsil Cleaner, 250 ml (FR)	5001780	9
WILAsil Cleaner, 250 ml (ES)	5001779	9
WILAsil Cleaner, 250 ml (EL)	500179	9

Breathing tube sleeve „WILAcover Nordkap“



Item	Part number	QTY
Breathing tube sleeve WILAcover Nordkap, grey	270158	10



LÖWENSTEIN
medical

7.04

6.0 cmH2O

- +

Prima SMART

☰ ▶

PRODUCT CATALOGUE



WILAmEd GmbH

Equipment for Professionals

Aurachhöhe 5-7
91126 Kammerstein, Germany

Tel.: +49(0)9178 99 69 99-0
E-Mail: info@wilamed.com
Web: www.wilamed.com

